

Dusty / Dusty Ex

Low-Cost
Broken Bag Detection

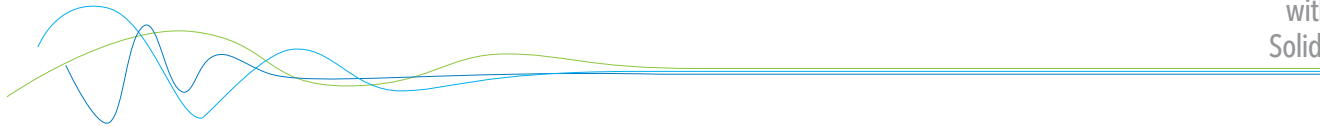



CONTENTS

	Page
1. Introduction	3
1.1 Safety	3
1.2 Product Overview	3
1.3 How does it work	4
2. Installation	5
2.1 Selecting the Installation Location	5
2.2 Installing the Sensor	6
3. Electrical Connection	7
3.1 Dusty as Stand Alone Dust Switch	7
3.2 Dusty with DIN Rail Converter	7
3.3 Connecting Multiple Sensors using the C3-Box	8
3.4 Dusty with M12 plug	8
3.5 DIN Rail Converter	9
3.6 Use in Ex Hazardous Areas	10
4. Dimensions	11
4.1 Sensor	11
4.2 DIN Rail Converter	11
4.3 Dimensions C1-Box (optional)	12
4.4 Dimensions C3-Box (optional)	12
5. Operation	13
5.1 Alert Level	13
5.2 One Button Operation	13
5.3 AutoSetup	14
5.4 DIN Rail Converter	14
5.5 Relay Output Configuration	15
6. PC-Software	17
6.1 Info Tab	17
6.2 DRC Tab	18
6.3 Sensor Tab	19
6.4 Trend Tab	21
7. DRC with Multiple Sensors	22
7.1 Register Sensors	22
7.2 Leading Sensor	22
8. Maintenance	24
9. Troubleshooting	24
10. Technical Data	25

1. Introduction

1.1 Safety

Dusty requires 24 ±10 % V DC power supply. 24 ±10 % V DC voltage level is considered as safe.

DIN Rail Converter requires 24 ±10 % V DC power supply. 24 ±10 % V DC voltage level is considered as safe.

Precautions:

The duct has to be opened at the installation and the maintenance.

Thereby some risks have to be considered:

- The flow of gas or dust can be hazardous to health.
- The flow can be inflammable, explosive or toxic.
- The gas can be hot or under pressure.

1.2 Product Overview

The Dusty is a microprocessor-based, pre-adjusted device, equipped with 1 switch for setup, 1 relay output and 3 LED, viewable when the cover is open.

The Dusty is designed for filter bag leak detection. It is a compact unit consisting of sensor and control electronics built into an IP 65 enclosure, which has been specifically designed for easy installation and operation.

Pre-adjusted alert level is on 25 mg/m³ of organic dust material at 14 m/s air velocity. If the measure of dust is higher than this alert level the relay output will be switched.

LEDs on the sensor show the status of measure, alarm output and internal function status.

Easy „One Button User Interface“ allows to increase/decrease the alert level, to perform a AutoSetup and to restore factory setting.

Optional there is a DIN Rail Converter providing a 4 ... 20 mA trend signal and replacing the relay output. With the DIN Rail Converter there is a PC software to increase/decrease the alert level, to perform a AutoSetup and to restore factory setting.

Optional there is a PC software to change additional parameter (filter time, hold time etc.) of the sensor, to view signal trends and to write protocol files.

The Dusty is designed for applications at up to 2 bars and 140 °C.

As an option the system can also be used in Ex-areas of category 3 (gas + dust).

The device is connected to a 4 wire cable in its internal terminal box.

1.3 How does it work

The Dusty works with its proven and reliable tribo-electric technology whereby the interaction of dust particles with the sensor rod causes a small electric charge, when the particles pass or strike by the sensor rod.

This small electric charge generates a signal proportional to the dust level even if there is an accumulation of particles on the sensor rod. Experience has shown that this method of sensing dust level in gases offers accurate results with a minimum of maintenance.

After start-up the sensor blinks on the LEDs for information purpose: the red LED blinks two times during system check, the orange LED blinks to inform about the actual factor of alert level (threshold).

Then the device starts to monitor the dust level and the green LED will blink with a frequency that shows the relation of actual measure against actual alert level: the lower the frequency the lower the measure.

If the measure goes higher the frequency goes faster, if the measure is equal or higher than the alert level the green LED stops blinking and the orange LED switches on. If the orange LED is switched on, the relay output is switched to indicate the alarm situation.

If the relay is used as "normally closed" (NC), the sensor is also monitored on power cut. Also any other fail will be alarmed via the relay.

With optional DIN Rail Converter the system provides a 4 ... 20 mA output as a trend of the dust load.

There is no need to maintain or set up the DIN Rail Converter and the output signal cannot be calibrated: a current of 4 mA means no dust in the duct, a current of 12 mA means that dust level is equal to alert level (switch-point of relay). Dust concentrations will be indicated linear up to 20 mA.

If there is an error found by internal system checks the output is set to 2 mA.

The relay output function of the sensor device is replaced by the DIN Rail Converter relay output due to alternative cabling between sensor and DIN Rail Converter.

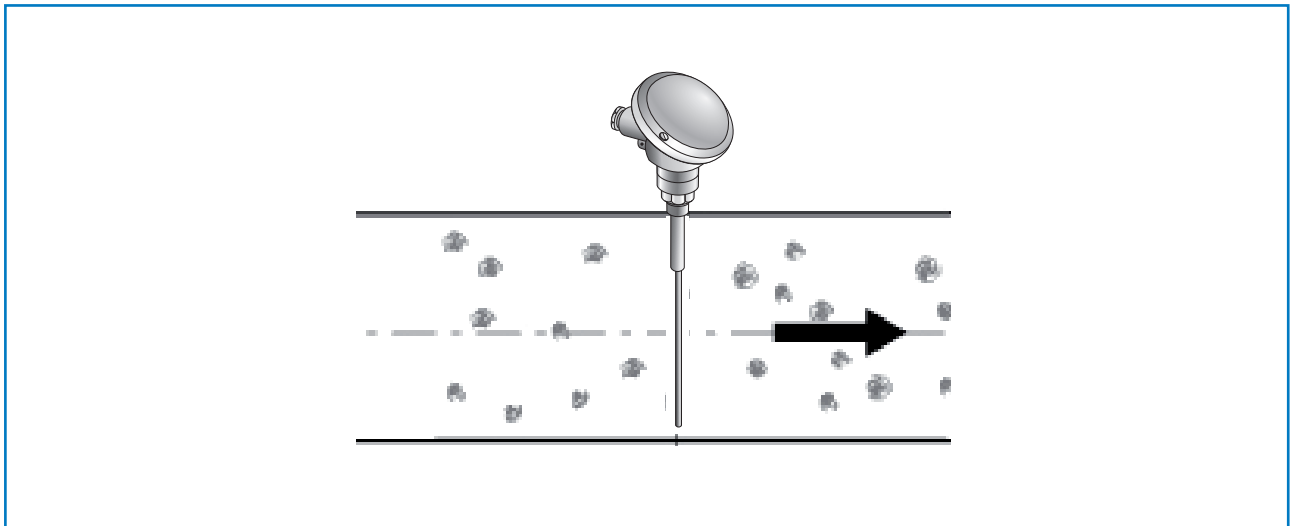

2. Installation

2.1 Selecting the Installation Location

The best location for installation of the Dusty is in a duct section where the flow has its most even distribution and the flow is as laminar as possible.

The installation can be located in a horizontal or vertical duct. For duct diameters larger than DN 600 the installation should be positioned at the exit of a curve on the centrifugal force side (see figure 1).

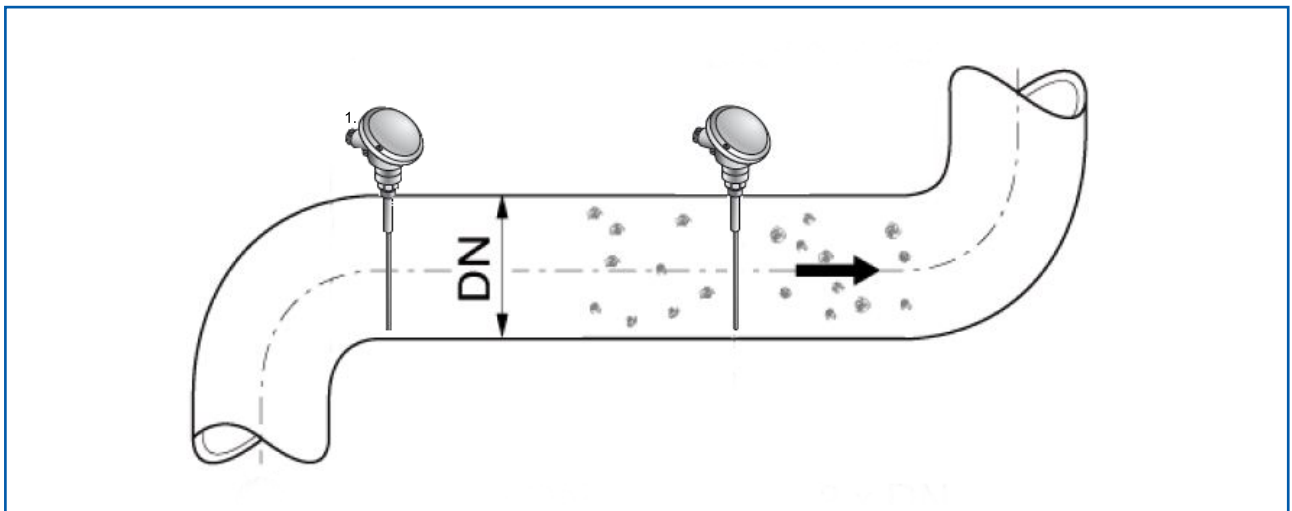

In some applications a compromise has to be made and the sensor will have to be fitted in a position that satisfies the majority of above requirements.

The Dusty housing must be attached to metal ductwork so that they will be electrically shielded from interference and be provided with a good grounding. For non-metal ducts, a section of the duct, approx. five diameters in length, should be covered with a metal foil or fine-mesh on the periphery of the duct.

1. The unit shall be installed in a position, where the gas flow passes the sensor rod in a 90° angle.
2. In round cross-section ducts the unit can be installed in any position above the horizontal axis (between 9 and 3 o'clock). (See figure 2a)
3. For square cross-section ducts, the unit must be positioned in the middle of the top or in the middle of one of the sides. (See figure 2b)
4. Although the sensor is not affected by vibration, very high vibration levels should be avoided.
5. The units should not be installed in direct sunlight or in areas where the ambient temperature is above 60 °C.

6. The sensor rod must not contact the opposite duct wall or any other obstacle inside the duct!
In cases of need the sensor rod can be shorten to a minimum length of 70 mm. Be careful not to damage the plastic cap by doing this.
 - The recommended length of the antenna is pipe diameter minus 10 mm. Certainly you have to insure that there will not come up any contact to the pipe, even there will grow any coating inside the pipe.
 - The minimum length of the antenna should be 1/3 of the pipe diameter.
 - A main rule is: the lower the dust concentration the longer the length of the antenna.
7. By monitoring a precipitator it is recommended to look for a sensor position behind the blower. If the sensor is to be used behind an electrostatic precipitator the distance to the precipitator should be a minimum of 20 m.
Even so the sensor function is not affected due to vibration, the sensor should not be exposed to high vibration during a long time period.

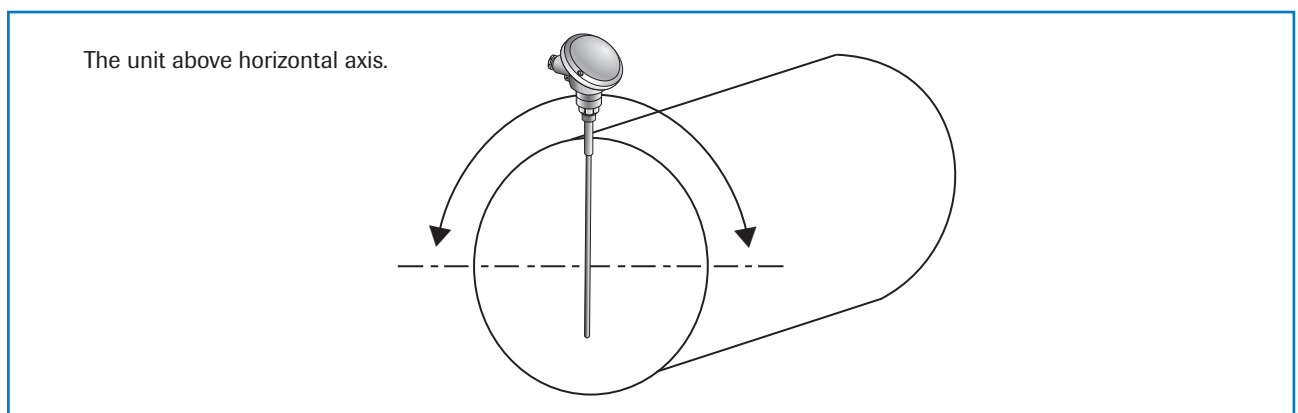

Fig. 2a: Round cross-section duct

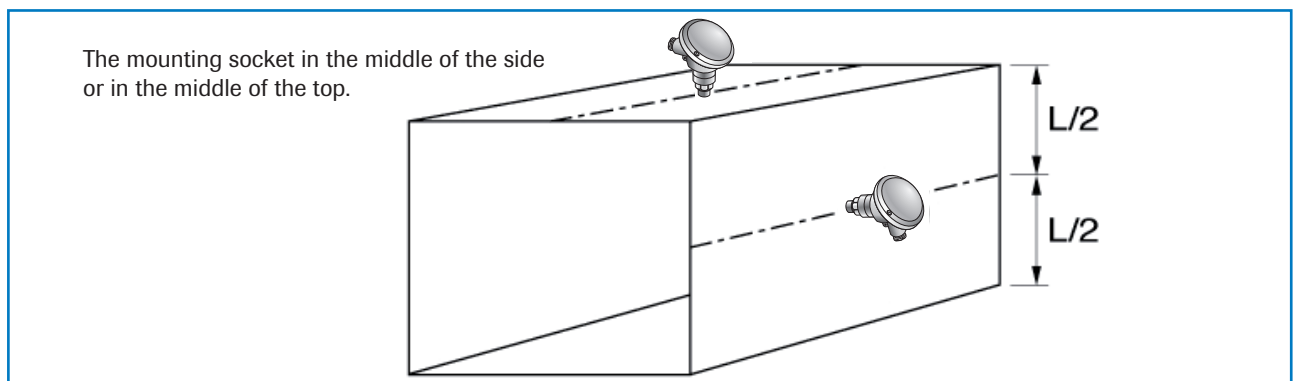

Fig. 2b: Square cross-section duct

2.2 Installing the Sensor

Once the location of the sensor has been selected, the G 1/2" female thread is welded on the duct wall and opened by drill completely. Then the G 1/2" male thread, of the sensor is screwed in until the connection is tight. Sealing has to be checked.

Caution:

- Use the correct tool (wrench size S 27) and place it on the G 1/2" screw connector. Do not screw the sensor in by hand since the screw connector could come loose and this can damage the electronics.
- Do not undo the grub screw in the housing plinth.
- Incorrect installation will void the warranty.

3. Electrical Connection

The Dusty is fit out with an internal wiring box, providing the plugs for different options:

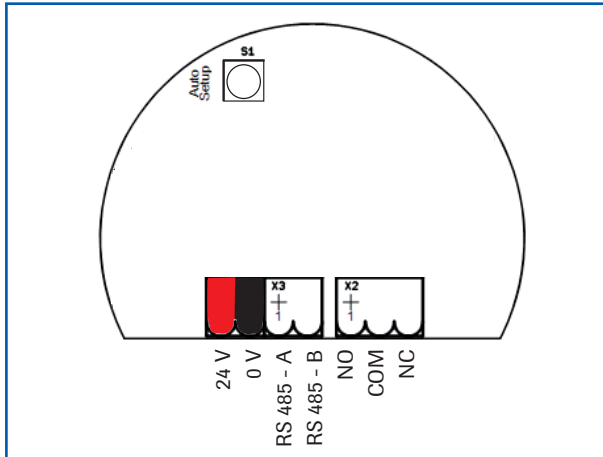

Plug number	Signal name
1	V+ (24 V DC)
2	V- (0 V)
3	RS 485 - A
4	RS 485 - B
5	Relay NO
6	Relay C
7	Relay NC

3.1 Dusty as Stand Alone Dust Switch

If used as a stand alone dust switch there are 4 wires to be installed.

Plug number	Signal name
1	V+ (24 V DC)
2	V- (0 V)
5	Relay NO
6	Relay C
7	Relay NC (alternative)

3.2 Dusty with DIN Rail Converter

If used with the DIN Rail Converter the 4 cable wiring can still be used but has to be altered on the plugs: If the DIN Rail Converter is used the relay output of the sensor is replaced by the relay output of the DIN Rail Converter.

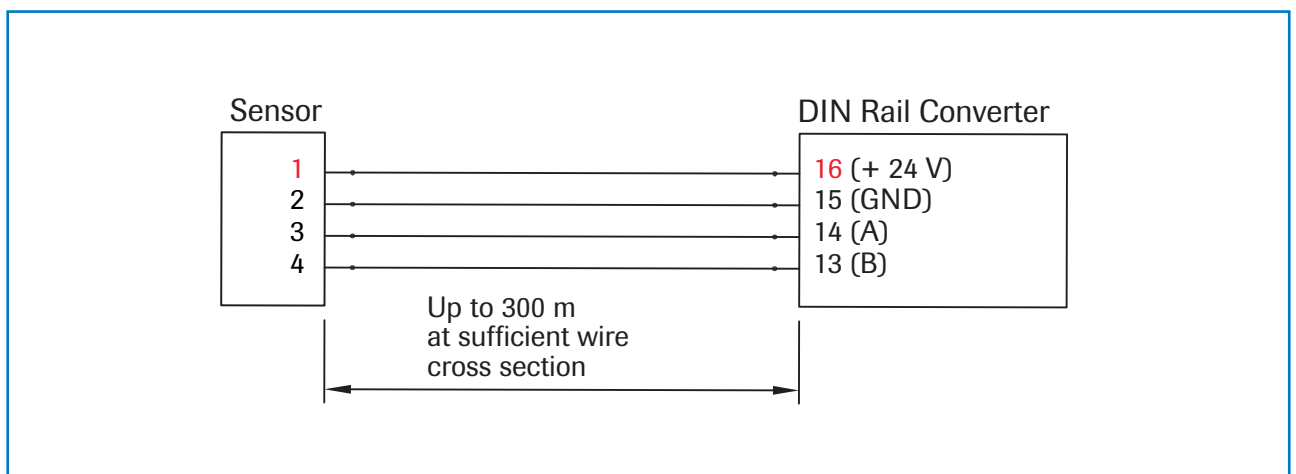

For long distances and noisy environment shielded cables and twisted pair wiring is recommended!

3.3 Connecting Multiple Sensors using the C3-Box

Up to three sensors can be connected to the DRC transmitter as an option via a C3-box to enable you to monitor large pipe cross-sections more easily.

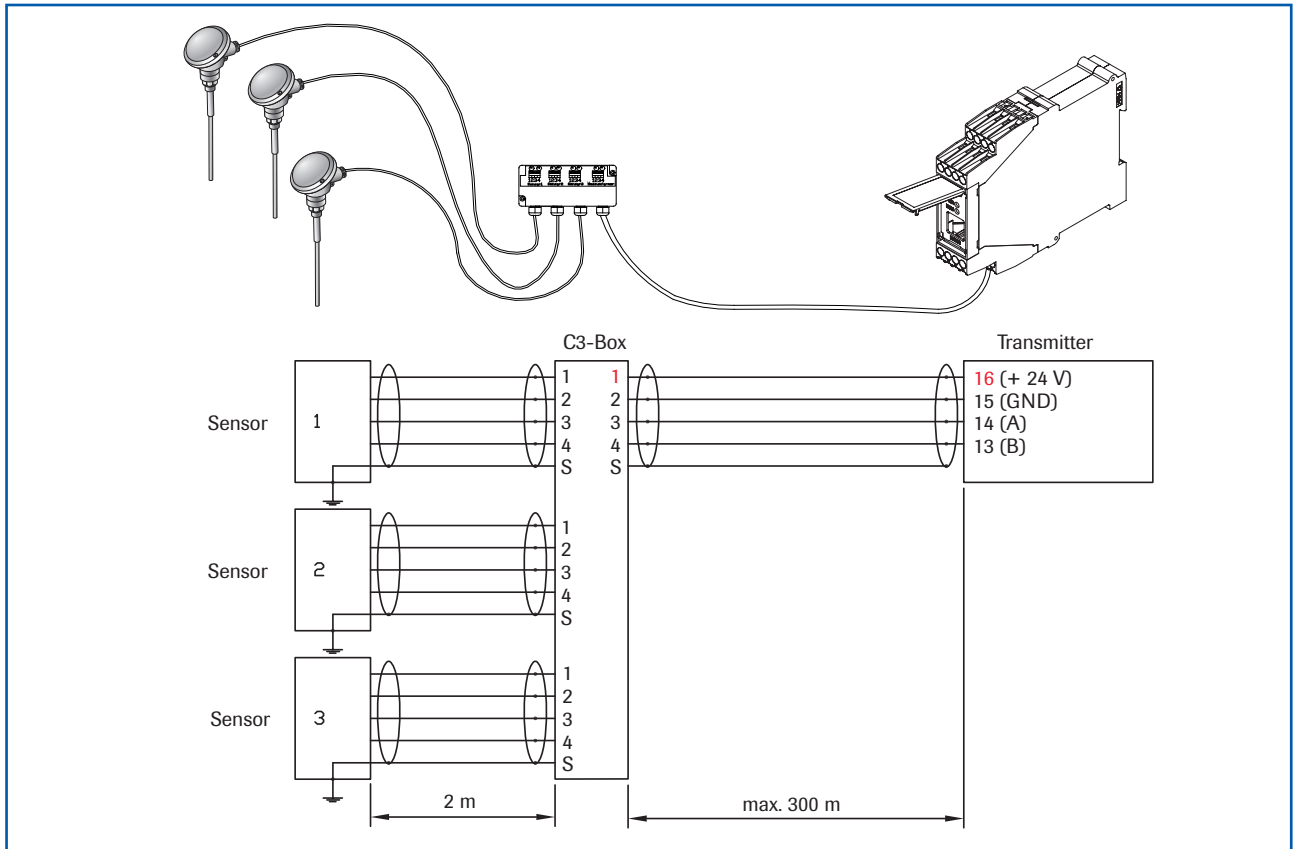

3.4 Dusty with M12 plug

SWR Dusty with M12 plug / socket

Plug No.	Signal
1	V (+24 V DC)
2	V (0 V)
3	ModBus A
4	ModBus B
5	Relay NO
6	Relay C
7	Relay NC

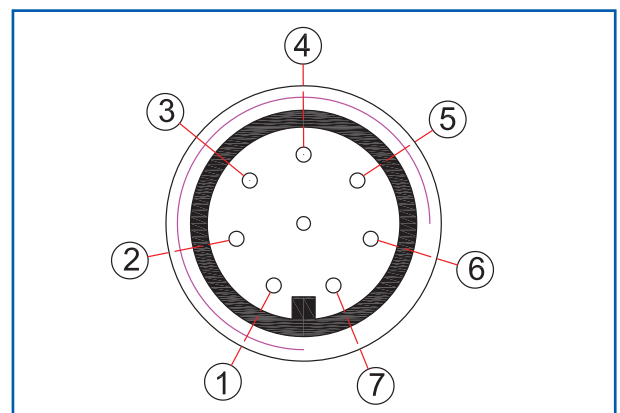

3.5 DIN Rail Converter

1 Current output - 4 ... 20 mA	2 Current output + 4 ... 20 mA	3 Input power supply 0 V DC	4 Input power supply + 24 V DC
5 Not reserved	6 Alarm relay NC (Opener)	7 Alarm relay C	8 Alarm relay NO (Closer)

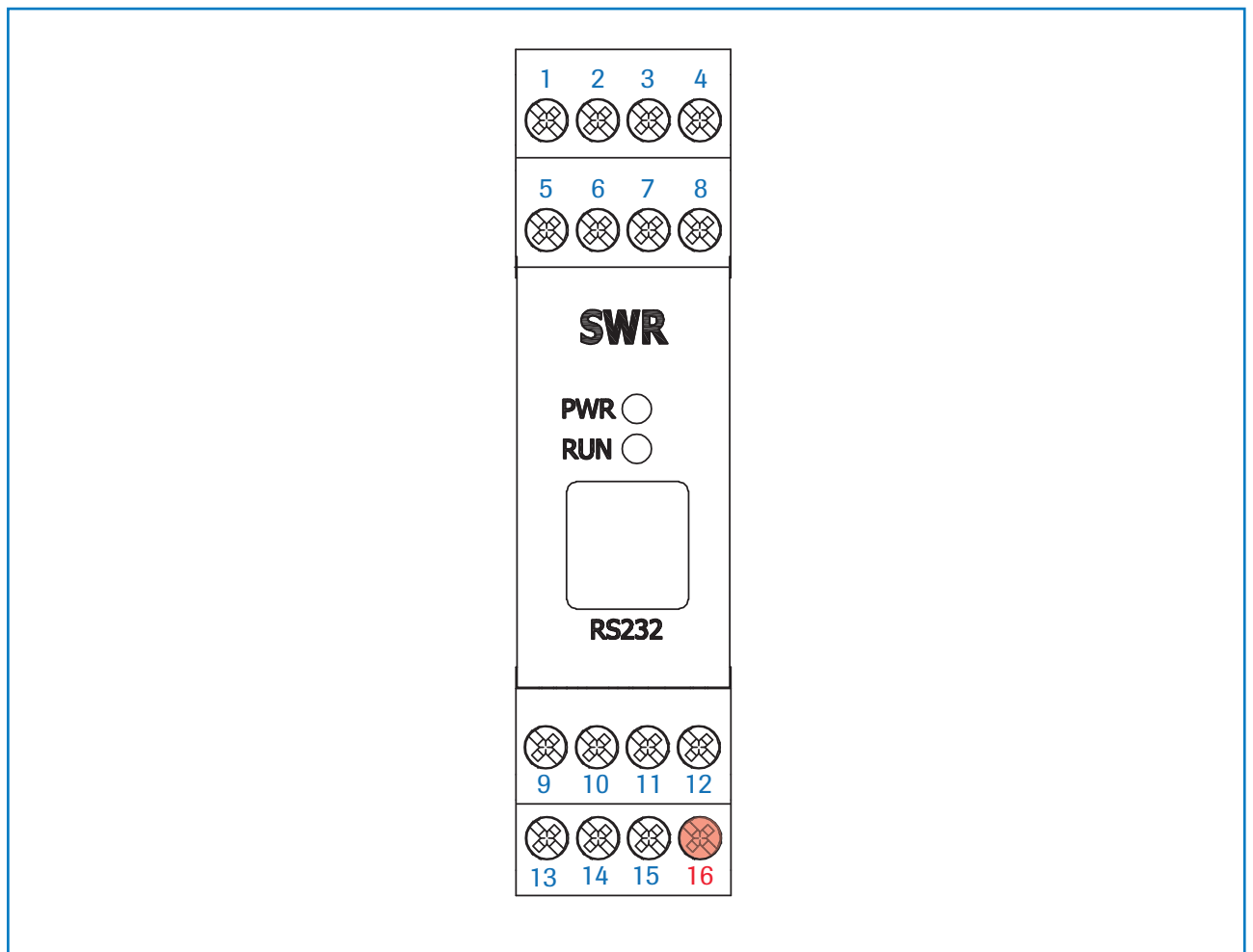

9 Not reserved	10 Not reserved	11 RS 485- interface data B	12 RS 485- interface data A
13 Sensor connection RS 485 Data B	14 Sensor connection RS 485 Data A	15 Sensor connection Power supply 0 V	16 Sensor connection Power supply + 24 V

3.6 Use in Ex Hazardous Areas

Marking DustEx:  **II 3D Ex ia/tc IIC 120 °C**

- Equipment group: 2
- Equipment category: 3
- For explosive mixtures of air and combustible dusts
- IP-code 66
- Permitted process temperature -20 to 120 °C

Marking GasEx:  **II 3G Ex ia/d IIC T4**

The sensor is not allowed to be used in areas of class IIC, in case of expected, intense charging processes.

- Equipment group: 2
- Equipment category: 3
- For explosive mixtures of air and combustible gases
- IP-code 66
- Permitted process temperature -20 to 120 °C

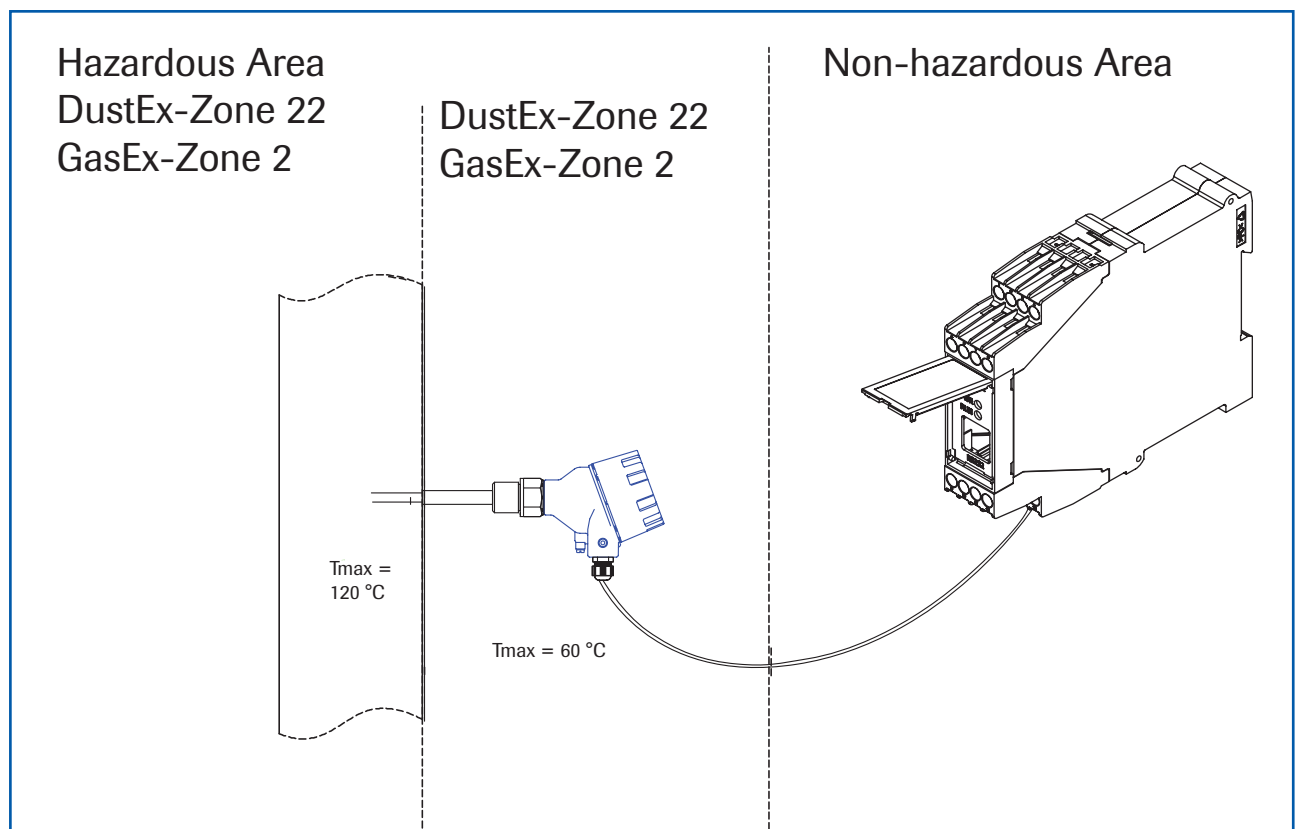

4. Dimensions

4.1 Sensor

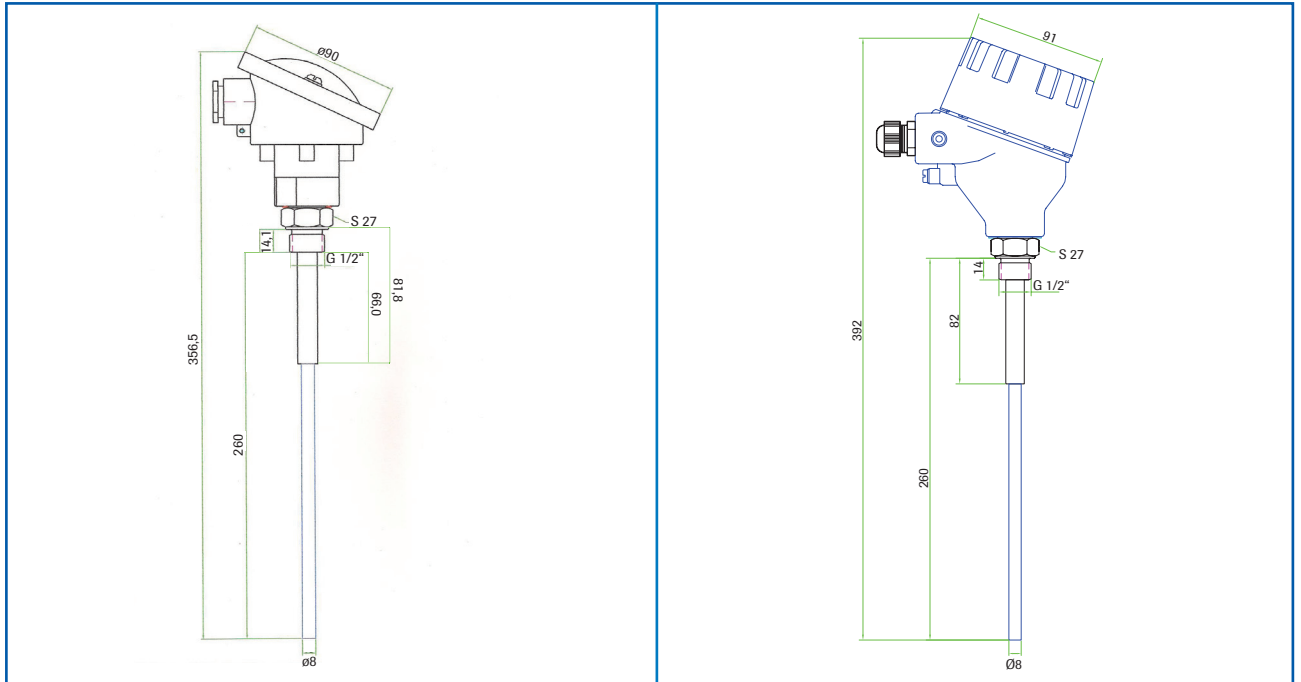

Fig. 3: Dimensions of Dusty Dusty Ex

4.2 DIN Rail Converter

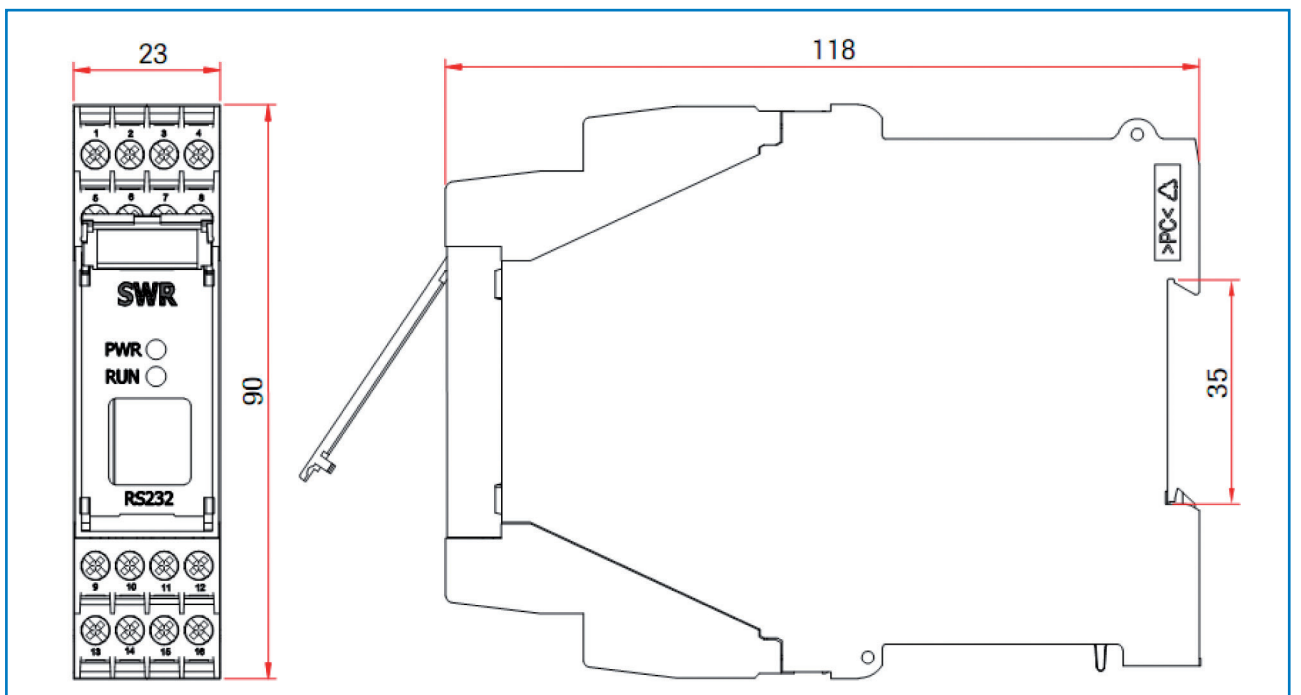

Fig. 4: Dimensions of DIN Rail Converter

4.3 Dimensions C1-Box (optional)

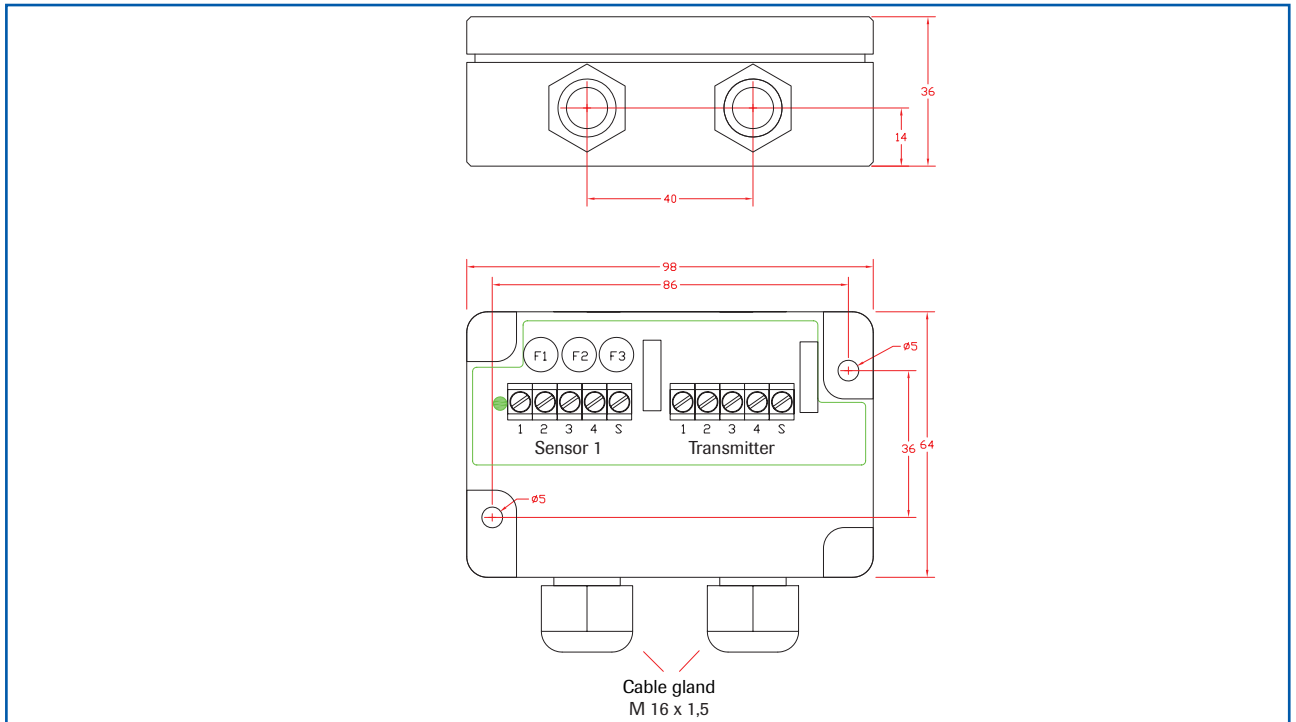

Fig. 5: Dimensions C1-Box

4.4 Dimensions C3-Box (optional)

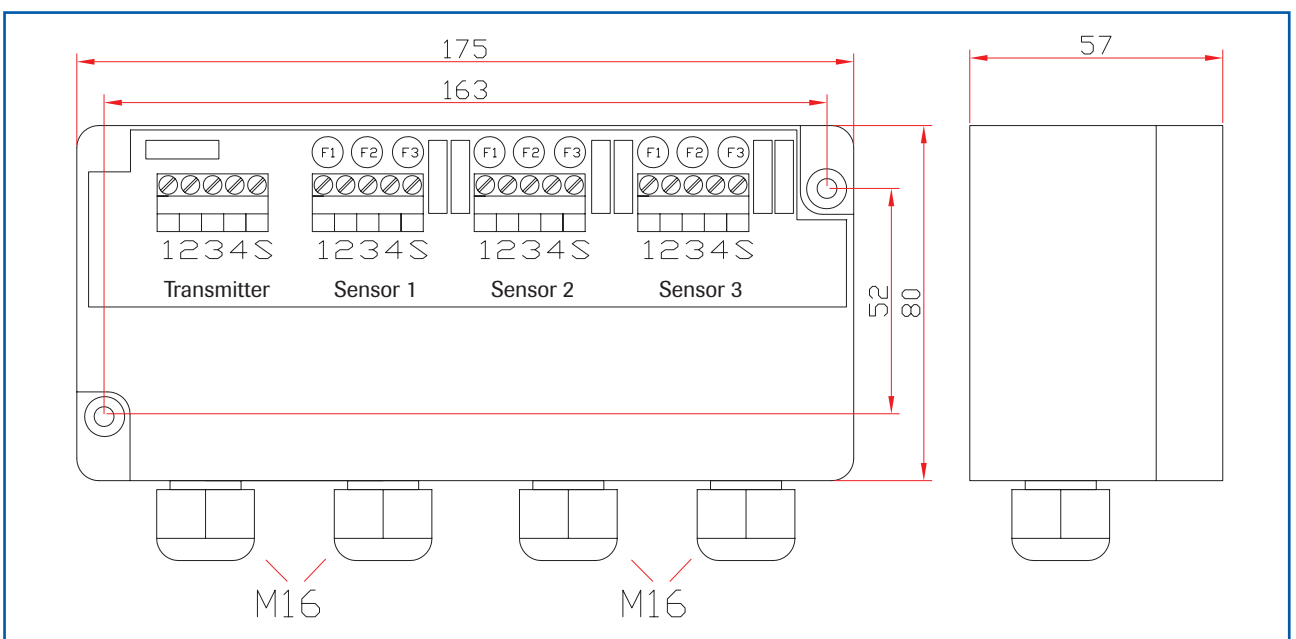

Fig. 6: Dimensions C3-Box

5. Operation

The sensor measures the dust level in a gas flow by collecting tribo-electric energy by dust particles hitting or passing near by the probe.

After start-up the sensor blinks on the LEDs for information purpose: the red LED blinks to inform about the actual ModBus address, the orange LED blinks to inform about the actual factor of alert level and then the green LED starts to blink with a frequency that shows the relation of actual measure against actual threshold: the lower the frequency the lower the measure. If the measure is high the frequency goes faster, if the measure is equal or higher than the alert level the LED stops blinking.

Measuring levels higher than the alert level will be indicated by the yellow LED in ON status. The relay contact works as an alarm output. If the measured dust level is higher than the alert level, the relay is activated (accordingly to the yellow LED).

Blinking of the red LED indicates an internal error.

5.1 Alert Level

The alert level is factory pre-adjusted to a level of approx. 25 mg/m³ of organic dust material at 14 m/s of air velocity.

This switching level is measured at the factory dust channel and is no absolute level for customers dust amount.

To adjust to customer's desire there is one button to increase or decrease the switching level by simply changing a multiplier factor. To change the factor see chapter 5.2 One Button Operation.

- An **internal measure value** is pre-calibrated to 5 mg/m³ in factory test duct
- A multiplier **factor** is pre-set to 5
- **Alert level** (threshold) is calculated with [**factor * internal measure value**] = [5 * 5 mg/m³]
- **Alert level** = 25 mg/m³
- Changing the **factor** to 4 means changing to **alert level = 4*5 mg/m³ = 20 mg/m³**
- Changing the **factor** to 10 means changing to **alert level = 10*5 mg /m³ = 50 mg/m³**
- Maximum **factor** is 30, maximum **alert level = 30*5 mg/m³ = 150 mg/m³**

Higher dust levels can be adjusted with AutoSetup function.

5.2 One Button Operation

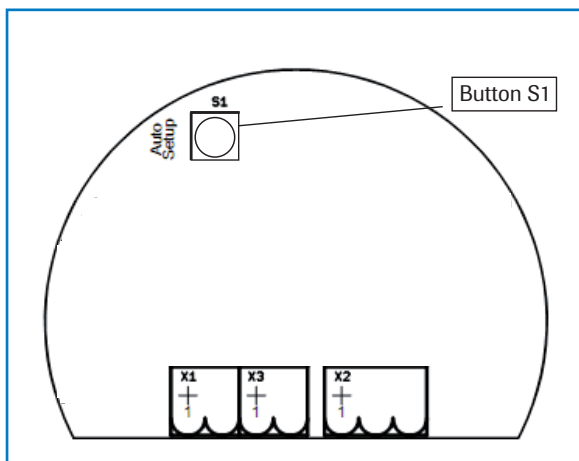

Pressing the button S1 will start a sequence of command options by blinking patterns. To get the desired function just RELEASE the button while it blinks accordingly!

1. Command sequence: Information only!

Release the button while all three LEDs are blinking up to 5 times in common: the red LED will blink out the sensors address and the yellow LED will blink accordingly to the actual factor.

2. Command sequence: Setup of factor:

Release the button while only the yellow LED is blinking: the factor is increased/decreased to the count of blinks of the yellow LED. Count the blinks to set new multiplier factor (max. 30 times)

3. Command sequence: AutoSetup!

After a countdown of all 3 LEDs the LEDs are blinking up to 5 times in common: release the button while blinking of the LEDs. Sensor will enter AutoSetup mode (see chapter 5.3 for details)

4. Command sequence: Restore the factory setting:

After a second countdown of all 3 LEDs the LEDs are blinking up to 5 times in common again: release the button while blinking of the LEDs to restore the factory pre-set for alert level (threshold) and factor.

The LEDs will go to OFF status after the last sequence. No changes are made after the LEDs are OFF.

5.3 AutoSetup

To set an individual alert level you can use the AutoSetup procedure. AutoSetup will count the actual level of dust in the duct and will store this value as internal measure value multiplied by factor as the new alert level (see chapter 5.1 alert level).

To use AutoSetup procedure, make sure that the process is running with a normal dust flow rate. Ensure that the device is powered on for at least 10 minutes. Open the cover of the device and initiate AutoSetup by pressing the button and release it accordingly to the description in chapter 5.2.

The LEDs will flash consecutively and the sensor will look for peaks in the measurement value to keep the highest possible measurement value during the process of AutoSetup The highest peak will be the internal measure value that will be multiplied by the factor to calculate the new alert level.

AutoSetup procedure takes 5 minutes to be completed, the LEDs stops flashing, green LED goes back into blinking state to indicate that the device is ready to use again.

AutoSetup procedure can be cancelled by pressing the button S1 during AutoSetup procedure. No changes will be made when AutoSetup is cancelled.

5.4 DIN Rail Converter

The DIN Rail Converter communicates with the sensor via digital bus line, so it needs to be wired in an alternative way.

If installed it takes the alert level value from the sensor as 12 mA point and zero as 4 mA point to calculate a linear function for the measure value. The measured value will be given as a current output value according to this linear function. So there is no need to set up any parameter on the DIN Rail Converter.

If the alert level is changed by changing the factor or by changing the alert value due to AutoSetup procedure the gradient of the function automatically will be adjusted.

The relay output of the DIN Rail Converter will show exactly the same behaviour as the relay output of the sensor.

There is a simple software to use the DIN Rail Converter and its digital communication to the sensor to achieve a remote control to the sensor, e. g. if the sensor is in an inconveniently installation situation.

5.5 Relay Output Configuration

By configuring the Dusty/DRC system correctly it is possible to achieve maximum monitoring and enable you to distinguish between sensor states.

5.5.1 Connection and Setting

Use the NC relay connectors on the sensor (plug contacts 6+7).

Plug No.	Signal
1	V+ (24 V DC)
2	V- (0 V)
5	Relay NO
6	Relay C
7	Relay NC (alternative)

Use the NC relay connectors on the DRC (terminals 6+7).

1 Current output - 4 ... 20 mA	2 Current output + 4 ... 20 mA	3 Input power supply 0 V DC	4 Input power supply + 24 V DC
5 Not reserved	6 Alarm relay NC (Opener)	7 Alarm relay C	8 Alarm relay NO (Closer)

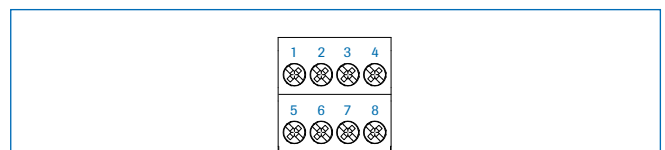

Set the "Relay INV" DIP switch in the sensor to the "Relay INV" position.

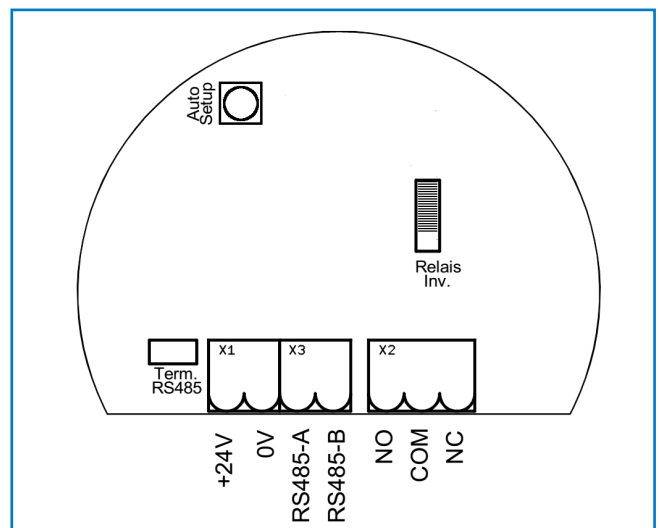

In the PC-software the software parameter DIN Rail Relay is NC active (default setting).

<input checked="" type="checkbox"/> AutoSETUP Time is fix	On/Off
<input checked="" type="checkbox"/> Hw Switch S1 is enabled	On/Off
<input checked="" type="checkbox"/> DIN Rail Relais is NC	On/Off

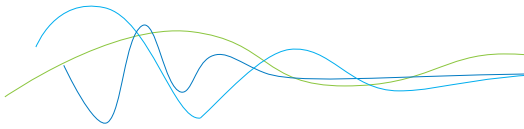

5.5.2 Dusty Relay Function

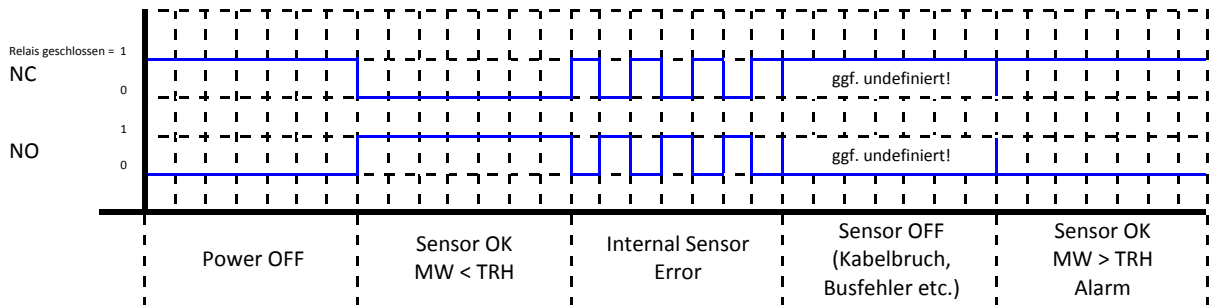

In the event that a cable breaks or is crushed, the state of the relay, but not the signal can be forecast at the PLC input and may be undefined.

5.5.3 Relay/Power Output Function DIN Rail Converter

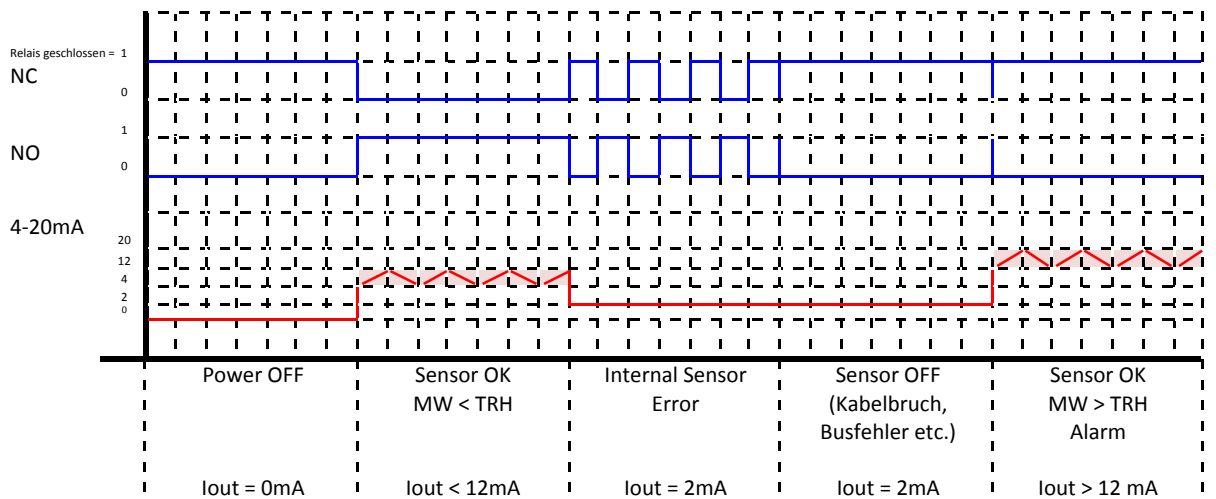

In the event that a cable breaks or is crushed, the state of the relay, but not the signal can be forecast at the PLC input and may be undefined.

6. PC-Software

The „Dusty Base“ PC-software can communicate with the system via ModBus. To achieve this the system must first be connected to the PC via the RS 486 interface.

If the software finds a DIN rail on the bus (DRC = DIN rail converter) the DRC relay is enabled, otherwise it will be displayed in grey (disabled). Operation with mixed systems is also possible.

If the DRC has been parameterised for one sensor, the PC software will only show on sensor.

If the DRC has been parameterised for multiple sensors, the display and operation will change.

The changes for a system with multiple sensors are summarised in the final paragraph of this section.

6.1 Info Tab

This is where the COM port, Baud rate and sensor address are set:

- ModBus address for direct sensor communication: 2
- ModBus address for DRC communication: 1

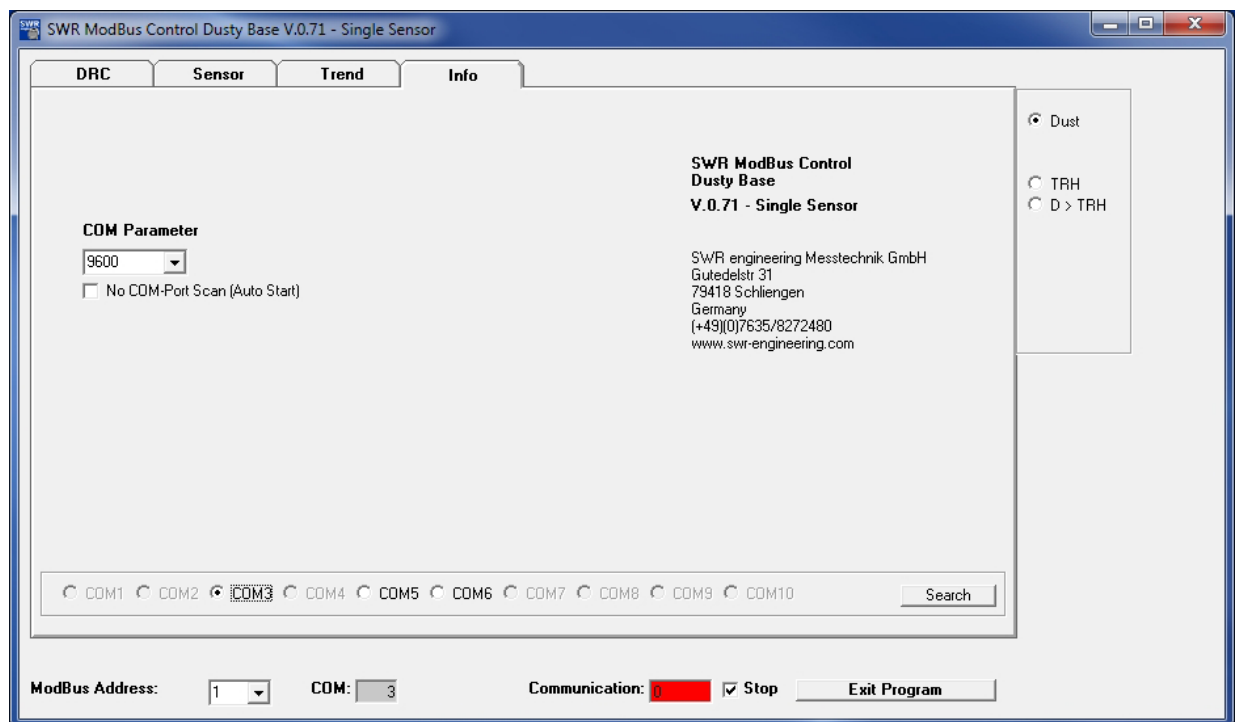

6.2 DRC Tab

If a suitable DIN rail DRC is found, the DRC can be configured here:

- ModBus address saved in the DRC
- Baud rate between PC and DRC
- Calibration of the power output
- ModBus addresses of any sensors

The sensors are registered with their ModBus addresses in fields Sensor #1, #2, #3.

If a zero is entered, the sensor is not scanned.

SWR ModBus Control Dusty Base V.0.71 - Single Sensor

DRC | Sensor | Trend | Info

DRC Setup

4 - 20 mA Calibration

4 mA start save

20 mA start save

Dev.ID 561
FW V.2.01

Sensor #1 (Leading Sensor)	2	1052	ModBus Address DRC	1
Sensor #2	0	0	Baud-Rate DRC	9600
Sensor #3	0	0		

Dust
 TRH
 D > TRH

ModBus Address: COM: Communication: Stop

6.3 Sensor Tab

Individual settings for the sensor can be made in the sensor tab.

The measurements for the sensor (metering) can be observed here and the basic parameters (Parameters) for the sensor can be set.

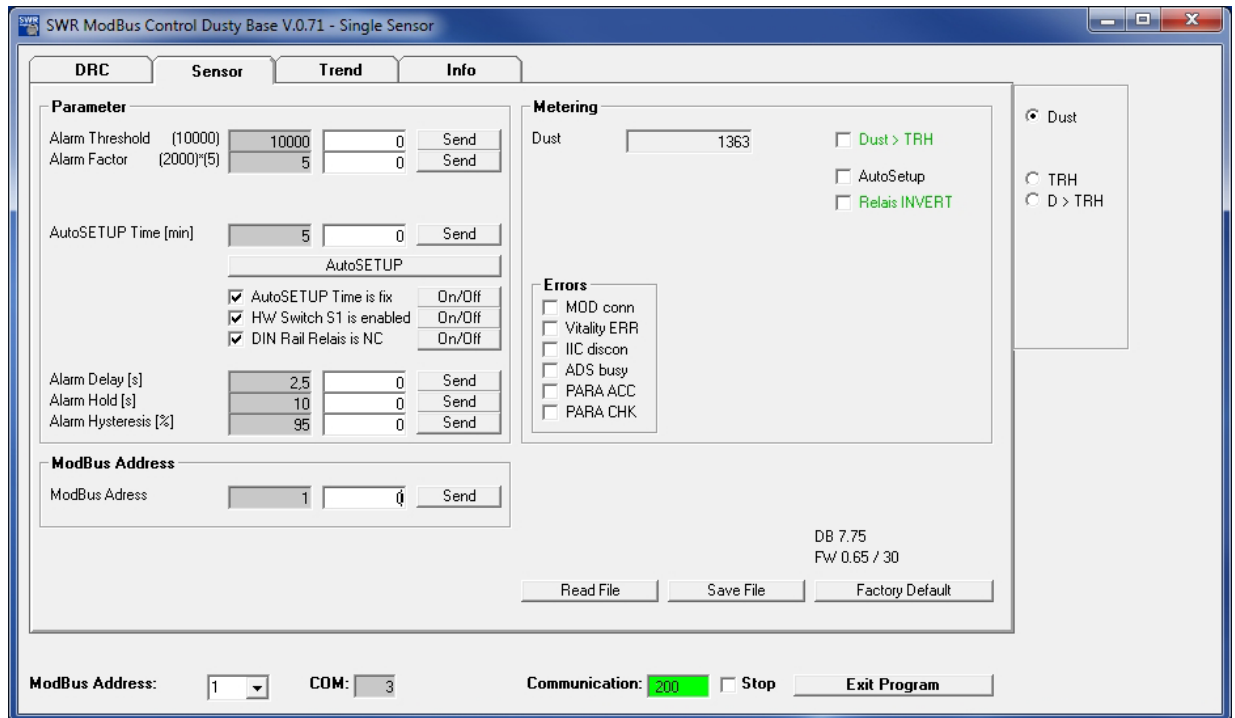

If errors are found in the sensor by internal system tests, they are marked and the sensor and the DRC display sensor error.

6.3.1 Basic Parameters

A default parameter set is established for a new destination system with an empty EEPROM:

Parameter	Default	Meaning
ModBus address:	2	Sensor
	1	DRC
TRH value:	10000	Current alarm threshold
TRH factor:	5	Factor
AutoSetup Time:	5	[min] time for AutoSetup function
Alarm Delay:	2.5	[s] No alarm until x seconds after the threshold is exceeded
Alarm Hold:	10	[s] The alarm is held for at least x seconds after the threshold value is exceeded.
Alarm Hysteresis:	95	[%] Alarm cannot be regarded as able to be cancelled until it falls below a figure of x percent of the threshold value.

Switch		
AutoSETUP Time is fix	1	Fixed, not automatically extended AutoSETUP time = AS Time
	0	With each new maximum value the Auto SETUP is extended by the set AS Time
HW Switch S1 is enabled	1	S1 is enabled
	0	S1 is ignored
DIN Rail Relais is NC	1	DIN rail relay is actuated as NC
	0	DIN rail relay is actuated as NO

6.3.2 AutoSetup

“AutoSetup” starts a search of the alarm value:

The sensor searched for the signal level which corresponds to the current dust load.

See section 5.3 for a detailed description.

6.3.3 Sensor Measurement Data

- Dust: the measurement for the dust load
- ✓ Delta > TRH: Alarm threshold TRH exceeded
- ✓ Relais INVERT: Switch relay INV to ON so that the alarm output (flag and sensor relay) are inverted
- ✓ Auto Setup: an AutoSetup has been initiated and is currently running

6.3.4 Internal Sensor Error

The “Error” indicator shows the results of function tests which run permanently whilst the system is running.

- ✓ MOD conn: ModBus connection is defective
- ✓ Vitality Error: restricted measurement range due to coating formation (conductive)
- ✓ IIC disconn: IIC bus defective
- ✓ ADS Busy: incorrect internal timing
- ✓ PARA ACC: EEPROM cannot be read/written
- ✓ PARA CHK: EEPROM supplying inconsistent data

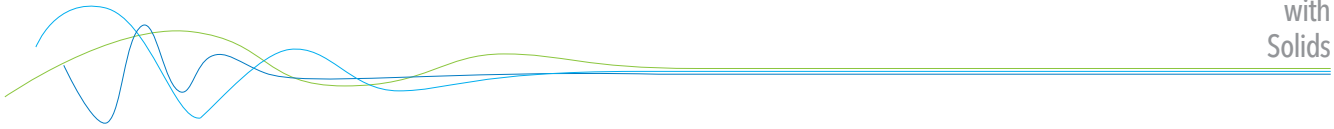

6.4 Trend Tab

The measurement and calculation values of the sensor can be observed here.

The sensor's dust value is always scaled on the left whilst the switch threshold or the relay output, for example, can be visualised on the right.

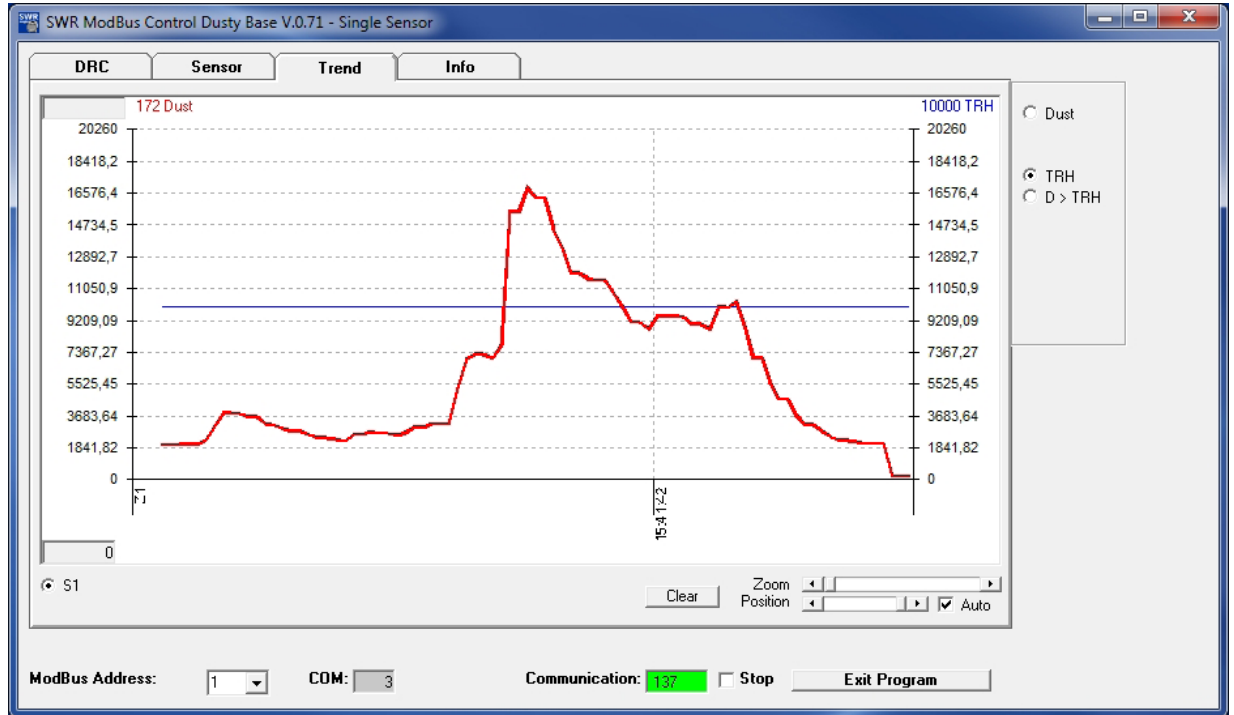

7. DRC with Multiple Sensors

7.1 Register Sensors

To register multiple sensors on the DRC, their ModBus addresses are entered as Sensor #1, #2, #3 and sent to the DRC.

If the sensors are in default mode (all at ModBus address 2), use the following procedure:

- Program the leading sensor to address 2 in the DRC and the other sensors to 1 and 3
- Connect the first sensor, send its ModBus address (for example 3) to the sensor
- Connect the next sensor, send its ModBus address (for example 1) to the sensor
- Connect the last sensor: finished.

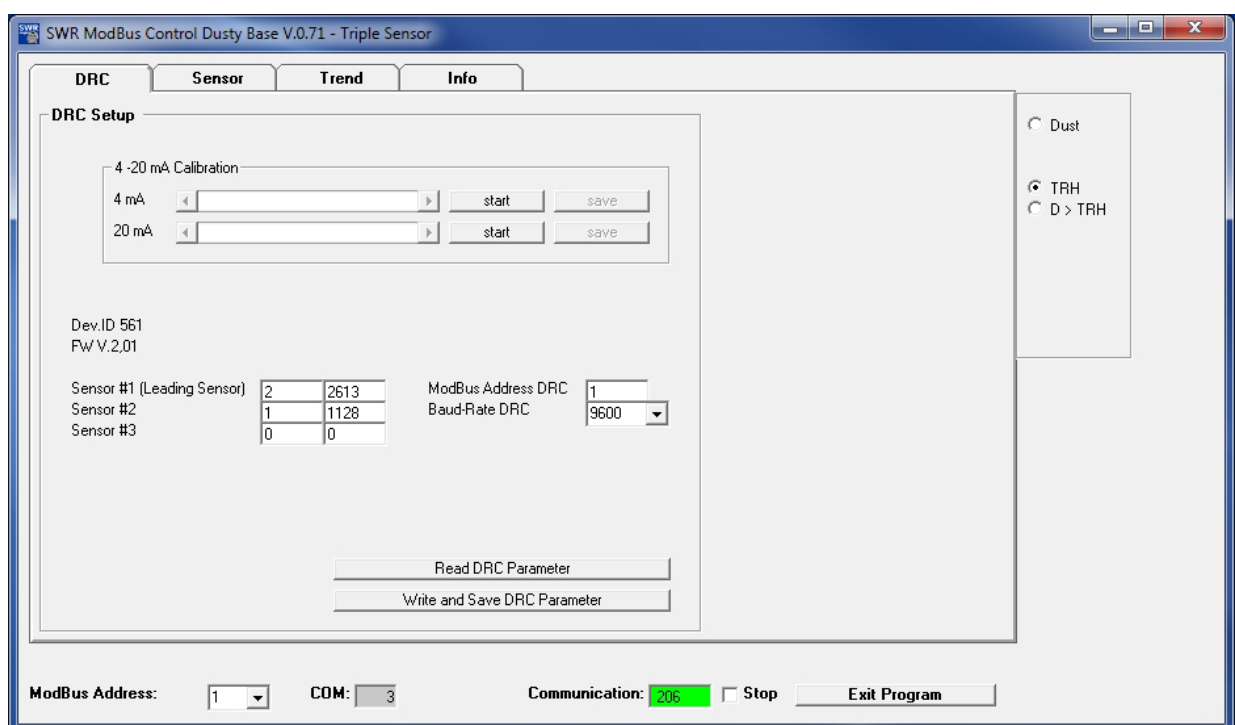

7.2 Leading Sensor

Only the sensor registered as sensor #1 (leading sensor) is shown in the PC-software.

In a 1-sensor system the DRC follows the sensor completely, in other words the sensor decides when the relay must switch and the DRC follows with its relay. The power output is set to the TRH value at 12 mA and then moves around this point depending on the dust value.

In a 2 or 3-sensor system, sensor #1 supplies the dust measurement and the TRH value switch threshold and the alarm delay and holding times to the DRC. The DRC uses all the dust values to calculate the arithmetic mean and then compares this mean to the TRH value of sensor #1.

This means that the DRC decides in this case when its relay switches and the holding and delay times it should use. Sensor #1 only saves the values.

The other sensors act as pure dust measurement suppliers but all sensors should be parameterised straight away.

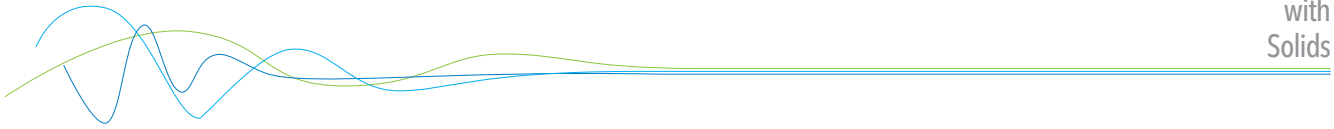

Dust now shows the mean values. The single readings are displayed in an additional line.
The Flag Dust > TRH of the individual sensor is not shown for it any more.

The screenshot shows the 'Sensor' configuration tab. It includes sections for 'Parameter', 'Metering', 'Errors', and 'ModBus Address'. The 'Parameter' section contains fields for Alarm Threshold (10000), Alarm Factor (5), AutoSETUP Time (5), Alarm Delay (2.5), Alarm Hold (10), and Alarm Hysteresis (95). The 'Metering' section shows a Dust reading of 1808 and checkboxes for 'Dust > TRH', 'AutoSetup', and 'Relais INVERT'. The 'Errors' section lists various error types like MOD conn, Vitality ERR, IIC discon, ADS busy, PARA ACC, and PARA CHK. The 'ModBus Address' section shows a value of 2. At the bottom, there are fields for ModBus Address (1), COM (3), and Communication (545).

In trend the individual sensors are shown as thin and the average value as thicker line.

The screenshot shows the 'Trend' tab with a line graph. The y-axis represents dust levels from 0 to 5331.6. The x-axis shows a time stamp of 15:57:16. A thick red line represents the average dust value, while three thin lines represent individual sensors. A horizontal line at the top of the graph is labeled '10000 TRH'. A legend at the bottom identifies the lines as 'Dust', 'Dust S1', 'Dust S2', and 'Dust S3'. The communication status at the bottom shows 'Communication: 651'.

8. Maintenance

For the maintenance the unit has to be removed from the process so that the sensor probe and the sensor insulation (white sleeve) can be cleaned.

Hereby it's possible to prevent deposit bridges between the sensor rod and the duct wall which could induce to a function failure or short-circuit.

If particles in the gas are sticky and tend to build up, the cleaning needs to be done more often. Inside the enclosure maintenance is not needed.

9. Troubleshooting

9.1 Output Relay Fails to Switch

1. Check the power supply and the connection contacts.
2. Check whether the green LED in the sensor is flashing (no alarm) or the yellow LED is lit (alarm):
This indicates a problem with the relay contact.
3. Check whether the red LED flashes during an active measurement: Error code!!

If the sensor is still not supplying signals after these checks, contact our agents or SWR engineering Messtechnik GmbH direct.

9.2 Measured Value Not Displayed even after AutoSetup

1. Check whether the process is running normally and whether the conditions were normal during the AutoSetup procedure.
2. Check the flashing frequency of the green LED and status of the yellow LED.
3. Check the power supply and the cabling.
4. Check for bridge formation and short circuit on the specimen probe.
 - Contact between probe and duct wall?
 - Bridge formation between probe and duct?
 - Casing formation around the probe due to condensate?

9.3 Relay Switches every Second: Coating Formation

If the sensor detects the formation of a conductive coating between the specimen probe and pipeline, it will signal this for the duration of the coating formation but for at least one minute by switching the relay (sensor or DIN rail) every second.

This instrument conforms to the following standards:

	Product standard - electrical equipment for measurement, control and laboratory use - EMC requirement
	Reference standard EN 61326
	Publication year (1997) amendment(s) A1 (1998), A2 (2001), A3 (2003)

10. Technical Data

Sensor	
Measurement objects	Solid particles in a gas flow
Measurement range	From 0.1 mg/m ³
Range setup	Pre-adjusted and automatic
Process temperature	Max. 140 °C
Ambient temperature	- 20 ... + 60 °C
Pressure	Max. 2 bar
Air speed	Min. 2 m/s
Humidity	95 % RH (non-condensing)
Measurement principle	Tribo-electricity (electrostatic detection)
Damping time	1 s
Output signals	1 relay output (NO / NC)
Alarm settings	Alert - dust level > threshold
Sensor rod	Total length: 260 mm, length of stainless steel rod: approx. 194 mm
Enclosure	Aluminium
Using in Ex-zones (Dusty Ex)	Cat. 3 G/D (zone 2 gas / zone 22 dust)
Protection category	IP 65, Dusty Ex IP 66
Power supply	24 ± 10 % V DC
Power consumption	1 W
Electrical connections	Internal connection box
Cable (power + signal)	4 wires
Process connection	G 1/2" male thread
Weight	Approx. 0.7 kg
DIN Rail Converter	
Power Supply	24 ± 10 % V DC
Power consumption	20 W / 24 VA
Protection category	IP 40 according to EN 60529
Operating temperature	-10 ... + 45 °C
Dimensions	23 x 90 x 118 (W x H x D)
Weight	Approx. 172 g
Cable cross section	0.2 - 2.5 mm ² [AWG 24-14]
Current output signal	4 ... 20 mA, load < 500 Ω
Alarm output Error output	Relay with toggle switch - max. 250 V AC, 1 A
Digital interface	ModBus RTU (RS 485)
Data protection	Flash memory

