



GTS, Inc.
PO BOX 799, Shalimar, FL 32579 USA
PH (850) 651-3388 FAX (850) 651-4777
EMAIL: info@onthelevel.com

Flow-Guard Series Non-Ex Versions Operating Manual



IMPORTANT
Read carefully before use.
Keep for future reference.

1 Contents

1	Contents	2
2	About this Document	4
2.1	Amendments	4
2.2	Validity	4
2.3	Symbols and Depictions	4
2.4	Safety Instructions	5
3	Device Description.....	6
3.1	Area of Application	6
3.2	Functionality	8
3.3	Technical Specifications	9
3.3.1	Common Technical Specifications of the Product Range	9
3.3.2	Technical Specifications and Mechanical Structure of the GM Version.....	11
3.3.1	Technical Specifications and Mechanical Structure of the K Version	13
3.3.2	Technical Specifications and Mechanical Structure of the P Version	15
3.3.3	Technical Specifications and Mechanical Structure of the S...E Version.....	16
3.3.1	Technical Specifications and Mechanical Structure of the S...T Version.....	17
3.3.2	Technical Specifications and Mechanical Structure of the V Version	18
4	Transport and Storage	19
5	Commissioning	20
5.1	Installation	20
5.1.1	Basic Preparations	20
5.1.2	Installation of a Flow-Guard GM	21
5.1.3	Installation of a Flow-Guard K	22
5.1.4	Installation of a Flow-Guard P	23
5.1.5	Installation of a Flow-Guard S...E.....	24
5.1.6	Installation of a Flow-Guard S...T	24
5.1.7	Installation of a Flow-Guard V	25
5.1.8	Finishing Tasks.....	26
5.2	Initial Start-up	27
5.3	Adjustment to the Process	27
5.3.1	Operational and Display Elements and their Uses.....	27
5.3.1.1	Operational and display elements of connection types 01, 02, 03 and 04.....	28
5.3.1.2	Operational and display elements of connection types 20 and 24.....	30
5.3.2	Configuring Instructions for Typical Areas of Application.....	31
5.3.2.1.1	Throughput Monitoring with Switch Output (Output Types 01, 02, 03 and 04).....	31
5.3.2.1.2	Throughput Monitoring with Current Output (Output Types 20 and 24).....	32
5.3.2.1.3	Filter Monitoring with Relay Output (Output Types 01, 02, 03 and 04).....	32
5.3.2.1.4	Filter Monitoring with Current Output (Output Types 20 and 24)	33
6	Operation.....	34

7	Servicing	35
8	Troubleshooting and Repair.....	36
9	Decommissioning.....	37
9.1	Dismantling	37
9.2	Disposal	37
10	Labelling.....	38
11	Applied Standards and Regulations.....	41
12	Input Configurations.....	42
13	Index	43

2 About this Document

2 About this Document

2.1 Amendments

Rev.	Date	Amendment
3	05/2017	Graphic improvements. Ex-components removed.

Tab. 1 Amendments

2.2 Validity

This document is valid for the following devices:









- Flow-Guard GM□
- Flow-Guard K□
- Flow-Guard P□
- Flow-Guard S□
- Flow-Guard V□

□ is a placeholder for any character.

These devices are hereinafter referred to as "sensors".

2.3 Symbols and Depictions

In our operating manuals, we use symbols to indicate particular risks and issues:

	General warning		Warning of high voltage
	Warning of radioactivity		Warning of hand injuries
	Instructions for an Ex-related issue		Wear foot protection
	Instructions for optimum and safe functioning		Wear a safety helmet

Tab. 2 Overview of warning symbols

2 About this Document

In our operating manuals, we use a multi-tiered system for warnings:

CAUTION

Hazard with a low level of risk which, if not avoided, can cause minor or moderate injury.

WARNING

Hazard with a medium level of risk which, if not avoided, can result in death or serious injury.

DANGER

Hazard with a high level of risk which, if not avoided, results in death or serious injury.

2.4 Safety Instructions

Read these operating instructions carefully before starting any work!

- Devices may only be installed, connected, operated and serviced by qualified and authorised personnel with special attention to these operating instructions, all relevant standards, legal requirements and certificates (depending on the application). The operating manual assumes that you have the required technical training for the mechanical and electrical work. Otherwise, please obtain the support of trained personnel.
- Follow the operating instructions precisely and proceed with care. Safety risks arise when there is deviation from the applications and procedures presented in this operating manual. Any deviations could invalidate the approval, warranty and responsibility of the manufacturer.
- The devices must not be used in ex-zones.
- Alterations with regard to installation and/or parameter settings may only be made in accordance with these operating instructions and with precise knowledge of the behaviour of a connected controller and the possible effects on the controlling operating process.
- Before opening the housing, switch on the device while disconnected from a power supply to avoid contact with any live parts and sparking.
- Electrostatic charges must be avoided. The device must be electrostatically grounded to be operated.



3 Device Description

3.1 Area of Application

Flow-Guard devices may only be used for flow monitoring of powder and bulk solids.

Flow-Guard devices with a switching output are intended for sites of application where mass throughputs of free-flowing solids, such as granulates, powders or particulate matter, do not have to be quantitatively measured, but rather where an assessment of condition (product is flowing or not flowing) is required.

Flow-Guard devices with a current output are intended for sites of application where a trend assessment of mass throughputs of free-flowing solids, such as granulates, powders or particulate matter, is required.

This device is only intended for use in an industrial environment.

The device must be closed and properly grounded during operation (see chapter 5.1) and the mechanical connections must be screwed to the pipeline with the prescribed torques.

No explosive hybrid mixtures may be passed through the inside of the pipelines.

Any other uses are prohibited. The use for liquids in particular is neither possible nor permitted.

3 Device Description

The areas of application of DYNAguard versions are as follows:

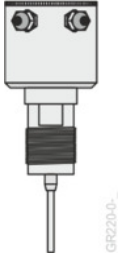
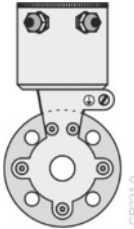
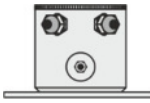
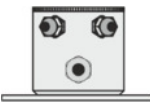
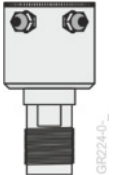
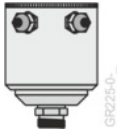
Version	Area of Application
<p>Flow-Guard GM</p>  <p>GRZ2040...</p>	<p>Particulate matter monitor to detect malfunctions in de-dusting plants that occur, for example, as a result of cracks or assembly errors.</p> <p>The sensor length should be 1/3 to 2/3 of the pipe diameter, and a maximum of 800 mm.</p> <p>The installation is carried out on metallic pipes on the clean gas side of the filter by welding on a threaded socket, drilling through the pipe and screwing on the particulate matter monitor.</p>
<p>Flow-Guard K</p>  <p>GRZ2140...</p>	<p>Compact device for easy installation between two DIN or ANSI flanges. The small thickness of the process connection also permits in most cases a subsequent installation in the existing conveyor pipelines without welding work.</p>
<p>Flow-Guard S...E</p>  <p>GRZ2340...</p>	<p>Device for hoses with a small diameter. The hose is cut through and inserted onto both ends of the device.</p>
<p>Flow-Guard S...T</p>  <p>GRZ2240...</p>	<p>Device for hoses with a small diameter. An electrically insulating hose is guided through and affixed by screw fittings on both sides.</p>
<p>Flow-Guard P</p>  <p>GRZ2440...</p>	<p>The detection area is 15 cm around the sensor surface so that moving components in the vicinity, such as valves, dosing screws, or rotary valves, do not lead to malfunctions.</p>
<p>Flow-Guard V</p>  <p>GRZ2540...</p>	<p>Versatile measuring electronics for connection to a variety of different process couplings in the ESR... series (separate documentation).</p>

3 Device Description

Three electronic versions are available:

Output	Sensitivity	Version
Relay	Standard	01
Relay	High	03
Transistor	Standard	02
Transistor	High	04
Current	Standard	20
Current	High	24

Tab. 3 Electronic versions

The devices are adjusted under normal transport conditions by means of switches and potentiometers. The alarm limit value (type -01/-02/-03/-04) is set with respect to these conditions, whereby the monitoring can be selected with respect to a lower or upper limit value.

A lower limit value is then monitored, for example, if blockages are detected at an early stage in the pneumatic conveyor pipelines, or if the addition of products is to be ensured in subsequent processes.

The monitoring of an upper limit value is used, for example, in the area of sieve monitoring (in the coarse grain pipeline) or emission measurement.

When two measuring devices are used, the switching signals can be used to determine the run times.

An adjustment that can be made via a slide switch and potentiometer and that has a dynamic range of about 1:180000 allows for use in emission monitoring at the lowest concentrations of 0.1 mg/m³, as well as in conveyor technology at dense flows of many t/h.

3.2 Functionality

The applied technology is based on the electrostatic principle, whereby the physical effect of the electrical charges of the solid particles is utilised. The particles electrically charged by natural means, such as by friction or fracture, generate (influence) a charge signal against the grounded transport channel when they pass the sensor surface.

Due to statistical fluctuations in the flow of particles, a current noise results, which increases both with the particle concentration and with the transport velocity.

The electronics set the level of this noise in relation to the mass throughput or concentration. The adjustment of the process is done manually via internal control elements.

Deposits on the sensor surface are not detected; only moving particles generate a signal. Caking, for example, therefore has no impact.

The device cannot be used with products that form an electrically conductive layer on the sensor system as a result of abrasion or caking.



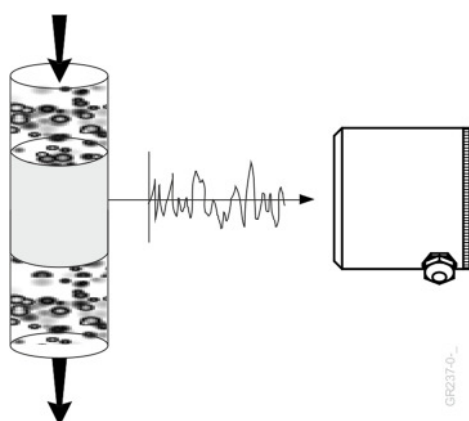

Fig. 1 Measurement of current noise by the sensor

3.3 Technical Specifications

Note: The technical specifications shown here apply to serial products. In case of doubt, please note the information on the label.

3.3.1 Common Technical Specifications of the Product Range

Parameter	Value
Power supply voltage	17 ... 31 V _{DC}
Power supply current, output type 01 and 02	Max. 60 mA
Power supply current, output type 20	Max. 90 mA
Fuse	500 mA, cannot be replaced by the customer
Signal output, output type 01 and 03	Potential-free relay, max. 48 V _{AC} /V _{DC} , 1 A
Signal output, output type 02 and 04	NPN transistor, galvanically isolated, max. 31 V _{DC} , 15 mA Inactive: Current < 100 µA Active: Voltage drop < 3 V
Signal output, output type 20 and 24	4 ... 20 mA, galvanically isolated Load < 500 Ohm
Maximum sensitivity	0.1 mg/m ³
Delay setting range, output type 01 and 02	0 ... 10 s
Delay setting range, output type 20	0 ... 120 s
Switch point setting range, output type 01 and 02	1 ... 10 relative
Ambient temperature of the head housing when in operation, standard temperature range	-20 ... +70°C (-4 ... +158°F)
Ambient temperature of the head housing when in operation, expanded (process) temperature range with PEEK insulation and silicon gasket, and HT option	-20 ... +50 °C (-4 ... +122 °F)

Process temperature	See version-specific data below
Required cables for the cable inlets	Cable inlet: M16 x 1.5 Sheath diameter: 4 ... 8 mm Cable cores: 0.14 ... 2.5 mm ² (rigid) 0.14 ... 1.5 mm ² (flexible)
Cable for potential equalisation	Min. 4 mm ²
International Protection Rating	IP65
EMC requirements	In compliance with EN 61326-1
Materials	See the following version-specific specifications.
Weight	See the following version-specific specifications.
Dimensions	See the following version-specific specifications.

Tab. 4 Technical specifications (general)

3 Device Description

3.3.2 Technical Specifications and Mechanical Structure of the GM Version

Individual parameters depend on the device version and can be found in the device name. The device names are itemised in chapter 10.

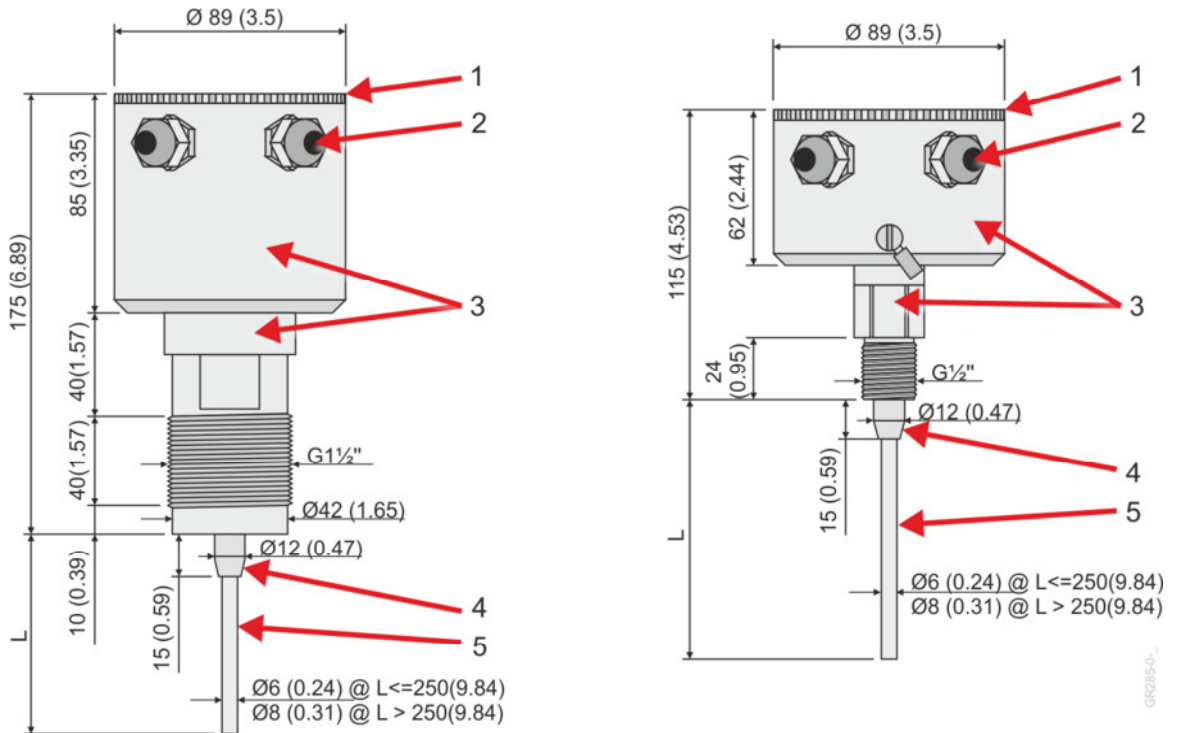

Fig. 2 Technical specifications and mechanical structure of the Flow-Guard GM G1.5 and G0.5 Dimensions in mm (in.)

- 1 Screw cap (stainless steel 1.4305 (AISI 303))
- 2 Cable inlet M16 x 1.5
- 3 Head housing (stainless steel 1.4305 (AISI 303))
- 4 Sensor insulation, material in accordance with device name Part e (see chapter 10)
- 5 Sensor rod, material in accordance with device name Part d (see chapter 10)

L in accordance with device name Part c (see chapter 10).

3 Device Description

Addition of HT option:

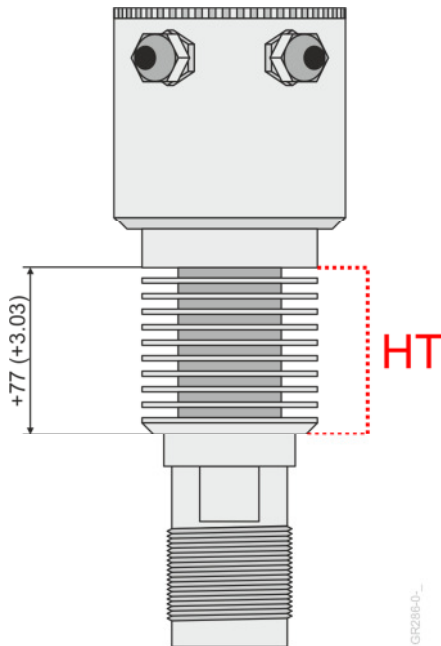

Fig. 3 HT option

Parameter	Value
Permissible process temperature Version ...a/b/c/d/51/f (see chapter 10) (Insulation: PA, gasket: all)	-20 ... +90 °C / (-4 ... +194°F)
Permissible process temperature Version ..._a/G1,5/c/d/30/20 (see chapter 10) (Insulation: PEEK, gasket: silicone or FPM)	-20 ... +140 °C / (-4 ... +266°F)
Permissible process temperature Version ... a/G1,5/c/d/30/20/ HT (see chapter 10) (Insulation: PEEK, gasket: silicone)	-20 ... +200 °C / (-4 ... +392 °F)
Permissible process temperature Version ...a/G1,5/c/d/32/40/ HT290 (see chapter 10) (Insulation: Tecasint 4011, Gasket: FFPM)	-20 ... +290 °C / (-4 ... +554 °F)
Permissible process pressure	6 bar (84 lbs)
Weight version ..._a/G0.5/c/d/e/f (see chapter 10)	Max. 2 kg
Weight version ..._a/G1.5/c/d/e/f (see chapter 10)	Max. 2.9 kg with HT option: max. 3.8 kg

Tab. 5 GM version technical specifications

3 Device Description

3.3.1 Technical Specifications and Mechanical Structure of the K Version

Individual parameters depend on the device version and can be found in the device name. The device names are itemised in chapter 10.

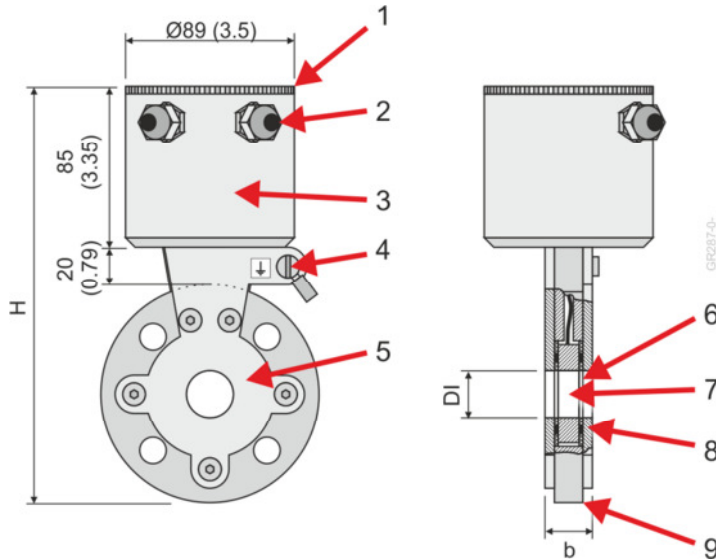

Fig. 4 Specifications and mechanical structure of DYNAGuard K
Dimensions in mm (in.)

- 1 Screw cap (stainless steel 1.4305 (AISI 303))
- 2 Cable inlet M16 x 1.5
- 3 Head housing I (stainless steel 1.4305 (AISI 303))
- 4 Grounding connection
- 5 Process coupling (stainless steel 1.4571 (AISI 316TI))
Hole pattern and outer diameter according to DIN 2527 or ANSI B16.5
- 6 Sensor insulation (PA)
- 7 Sensor ring (stainless steel 1.4571 (AISI 316TI))
- 8 Gasket (silicone, FPM in silicone-free version)
- 9 Sensor housing (stainless steel 1.4571 (AISI 316TI))

Nominal diameter	H	b	Standard diameter DI	
			Row 1	Row 2
10	195 (7.68)	20 (0.78)	10.4 (0.41)	13.6 (0.54)
15	200 (7.87)	20 (0.78)	16.0 (0.63)	17.3 (0.68)
20	210 (8.27)	20 (0.78)	20.4 (0.80)	22.3 (0.88)
25	220 (8.66)	25 (0.94)	24.8 (0.98)	28.5 (1.22)
32	245 (9.65)	25 (0.94)	32.8 (1.29)	37.2 (1.46)
40	255 (10.04)	25 (0.94)	39.3 (1.55)	43.1 (1.70)
50	270 (10.63)	25 (0.94)	51.2 (2.02)	54.5 (2.15)
65	290 (11.42)	25 (0.94)	70.3 (2.77)	-
80	305 (12.01)	25 (0.94)	82.5 (3.25)	-
100	325 (12.80)* 340 (13.39)**	30 (1.18)	100.8 (3.97)	107.1 (4.22)

Tab. 6 Dimensions for DIN flanges in mm (inches)

* PN10/16

**PN25/40

3 Device Description

Nominal diameter	H	H	b	Standard diameter DI
DN	150 lbs	300 lbs		
1/2"	194 (7.63)	200 (7.87)	20 (0.87)	15.7 (0.622)
3/4"	204 (8.03)	222 (8.74)	20 (0.87)	20.8 (0.824)
1"	213 (8.39)	229 (9.02)	25 (0.94)	26.7 (1.049)
1 1/4"	222 (8.74)	238 (9.37)	25 (0.94)	35.1 (1.380)
1 1/2"	232 (9.13)	260 (10.24)	25 (0.94)	40.9 (1.610)
2"	257 (10.12)	270 (10.63)	25 (0.94)	52.6 (2.067)
2 1/2"	283 (11.14)	296 (11.65)	25 (0.94)	62.7 (2.469)
3"	296 (11.65)	315 (12.40)	25 (0.94)	78.0 (3.068)
3 1/2"	322 (12.68)	334 (13.15)	30 (1.18)	90.2 (3.548)
4"	335 (13,19	359 (14.13)	30 (1.18)	102.4 (4.031)

Tab. 7 Dimensions for ANSI flanges in mm (inches)

Parameter	Value
Permissible process temperature	-20 ... +90°C (-4 ... +194°F)
Permissible process pressure	See device name (label) Part c
Weight (flange-dependent)	1.2 ... 6.7 kg

Tab. 8 K version technical specifications

3 Device Description

3.3.2 Technical Specifications and Mechanical Structure of the P Version

Individual parameters depend on the device version and can be found in the device name. The device names are itemised in chapter 10.

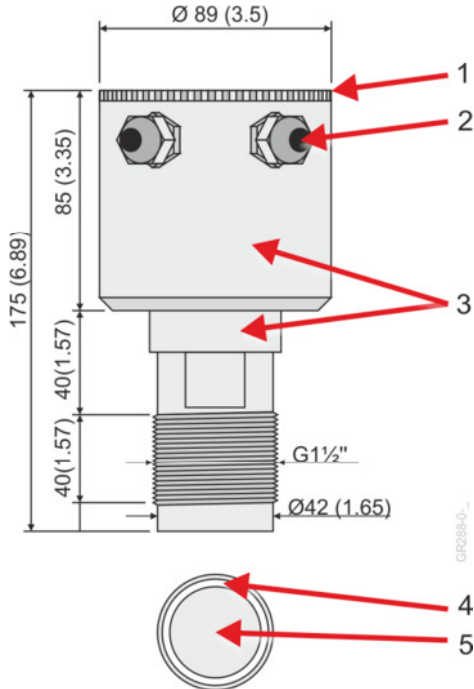

Fig. 5 Technical specifications and mechanical structure of Flow-Guard P Dimensions in mm (in.)

- 1 Screw cap (stainless steel 1.4305 (AISI 303))
- 2 Cable inlet M16 x 1.5
- 3 Head housing (stainless steel 1.4305 (AISI 303))
- 4 Sensor insulation, material in accordance with device name Part d (see chapter 10)
- 5 Sensor plate, material in accordance with device name Part c (see chapter 10)

Addition of HT option:

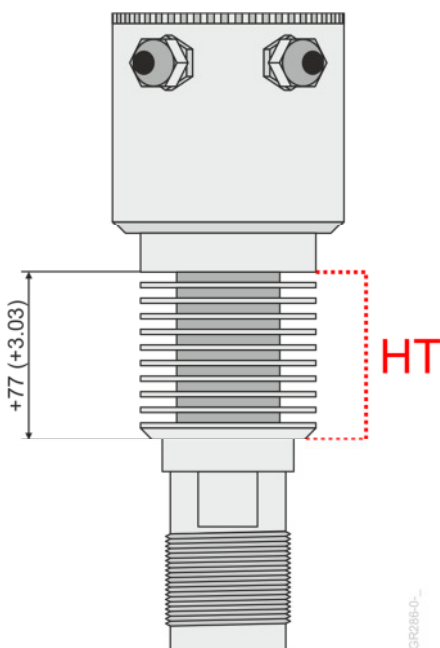

Fig. 6 HT option

3 Device Description

Parameter	Value
Permissible process temperature Version ...a/b/c/d/51/f (see chapter 10) (Insulation: PA, gasket: all)	-20 ... +90 °C / (-4 ... +194°F)
Permissible process temperature Version ..._a/G1,5/c/d/30/20 (see chapter 10) (Insulation: PEEK, gasket: silicone or FPM)	-20 ... +140 °C / (-4 ... +266°F)
Permissible process temperature Version ... a/G1,5/c/d/30/20/HT (see chapter 10) (Insulation: PEEK, gasket: silicone)	-20 ... +200 °C / (-4 ... +392 °F)
Permissible process temperature Version ...a/G1,5/c/d/32/40/HT290 (see chapter 10) (Insulation: Tecasint 4011, Gasket: FFPM)	-20 ... +290 °C / (-4 ... +554 °F)
Permissible process pressure	6 bar (84 lbs)
Weight	2.2 kg with HT option: 3.1 kg

Tab. 9 P version technical specifications

3.3.3 Technical Specifications and Mechanical Structure of the S...E Version

Individual parameters depend on the device version and can be found in the device name. The device names are itemised in chapter 10.

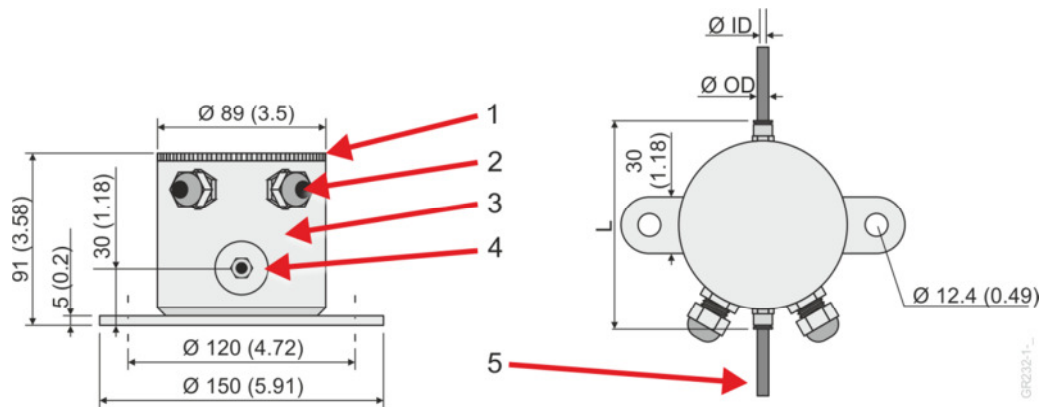

Fig. 7 Specifications and mechanical structure of Flow-Guard S...E Dimensions in mm (in.)

- 1 Screw cap (stainless steel 1.4305 (AISI 303))
- 2 Cable inlet M16 x 1.5
- 3 Head housing I (stainless steel 1.4305 (AISI 303))
- 4 Hose connection
- 5 Hose (not included)

Ø OD	Ø ID	L
4	2.7	113 (4.45)
6	4	116 (4.57)
8	6	132 (5.20)
10	8	129 (5.08)
12	10	144 (5.67)

3 Device Description

14	12	146 (5.75)
16	13	155 (6.10)

Tab. 10 Hose-dependent dimensions in mm (in.)

Parameter	Value
Permissible process temperature	-20 ... +70°C (-4 ... +158°F)
Permissible process pressure	10 bar (140 lbs)
Weight	1.5 kg

Tab. 11 Technical specifications for S...E version

3.3.1 Technical Specifications and Mechanical Structure of the S...T Version

Individual parameters depend on the device version and can be found in the device name. The device names are itemised in chapter 10.

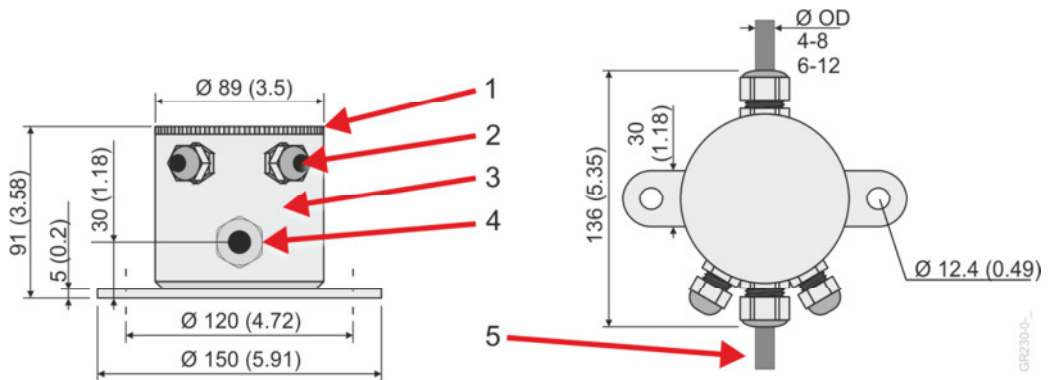

Fig. 8 Technical specifications and mechanical structure of Flow-Guard S...T Dimensions in mm (.in)

- 1 Screw cap (stainless steel 1.4305 (AISI 303))
- 2 Cable inlet M16 x 1.5
- 3 Head housing I (stainless steel 1.4305 (AISI 303))
- 4 Hose inlet
- 5 Hose (not conductive, not included)

Parameter	Value
Permissible process temperature	-20 ... +70°C (-4 ... +158°F)
Permissible process pressure	Specified by hose
Weight	1.6 kg

Tab. 12 Technical specifications for S...T version

3 Device Description

3.3.2 Technical Specifications and Mechanical Structure of the V Version

Individual parameters depend on the device version and can be found in the device name. The device names are itemised in chapter 10.

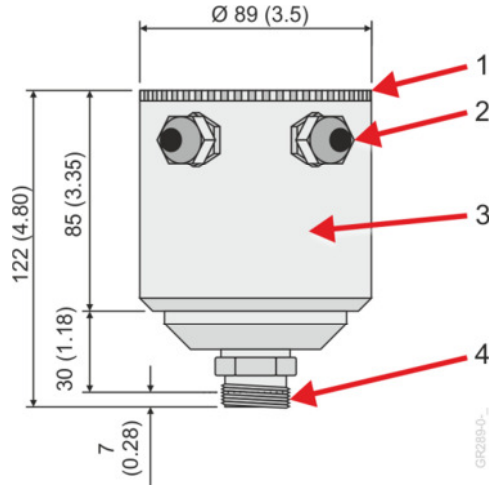

Fig. 9 Technical specifications and mechanical structure of Flow-Guard V
Dimensions in mm (in.)

- 1 Screw cap (stainless steel 1.4305 (AISI 303))
- 2 Cable inlet M16 x 1.5
- 3 Head housing I (stainless steel 1.4305 (AISI 303))
- 4 Screw connection (stainless steel 1.4305 (AISI 303))

Parameter	Value
Permissible process temperature	See ESR documentation
Permissible process pressure	See ESR documentation
Weight	1.5 kg

Tab. 13 Technical specifications for V version

4 Transport and Storage

All system components require non-corrosive ambient conditions during transport, storage and operation.

Transport the product in its original packaging.

5 Commissioning

5.1 Installation

5.1.1 Basic Preparations

WARNING



Danger of product leakage (or pressurisation).

Depressurise the conveyor pipeline before installation.

Leaking product may result in injury to any unprotected body parts.

Follow the nationally applicable installation guidelines.

Ensure a proper installation so that the IP classification is maintained.

The device may only be used as intended. The interconnection with external electrical equipment must be checked for compliance with the technical regulations.

The device is protected against the penetration of particulate matter and water as indicated by an IP classification (see chapter 9). Protect the device against excessive contamination from particulate matter and water (such as during outdoor use), especially if this contamination exceeds the classification.



For process temperatures above 80°C, the sensor electronics must be thermally isolated from the process so that the permissible ambient temperature (see chapter 3.3) is maintained. Special device versions are available for high process temperatures. Do not place the head housing above any hot pipes so as to avoid exposure to rising heat. Thermal insulation may not enclose the head housing as this may lead to overheating of the electronics and ultimately to malfunctions or destruction of the electronics.

The head housing must be heated at temperatures below -20°C.

The head housing may heat up in direct sunlight. In such a case, provide shading in the form of a weather protection hood.

Avoid vibrations of the conveyor pipeline at the site of installation.

The installation of the electric circuit must be done in accordance with the applicable regulations (proof of the installer's expertise, protected routing, etc.).

Ensure that the provided operating voltage corresponds to the information in the technical specifications (see chapter 3.3.1).



The housing and connection may only be opened in a voltage-free state. The PE connection is to be made with low inductance with the PE of the system in accordance with the local regulations. The connecting pipelines must be permanently installed outside of the operating equipment. All cable and wire entries must be closed in accordance with the manufacturer's specifications.

Avoid electrostatic charges. Ground the device. The grounding is different depending on the device type:

5 Commissioning



In general, the measuring principle allows for installation in any position (horizontal, vertical, oblique). The measurement result shows few fluctuations over time when the material flows through the sensor as uniformly as possible. An installation where the product flows vertically downwards through the sensor is therefore preferred (especially for more concentrated currents at low transport velocities). Provide the following calming sections if possible:

- Inlet section 10x inner diameter with pneumatic conveyance, 2x inner diameter in the event of a falling process.
- Outlet section 5x inner diameter with pneumatic conveyance, 2x inner diameter in the event of a falling process.

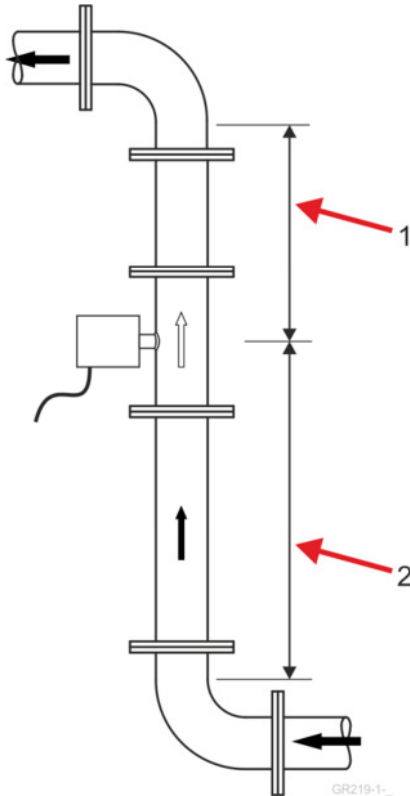

Fig. 10 Inlet and outlet sections

- 1 Outlet section
- 2 Inlet section

Procedure:

1. Check for proper grounding of the pipeline and all relevant components.
2. Provide the cables (see chapter 3.3.1).
3. Ensure that the designated power supply voltage corresponds with the voltage specified on the label.

5.1.2

1. Weld on the welding sockets.
2. Drill into the process pipe through the welding sockets (centric, at least 13 mm (0.5 in)).

5 Commissioning

- 3. Apply PTFE sealant to the screw threads:

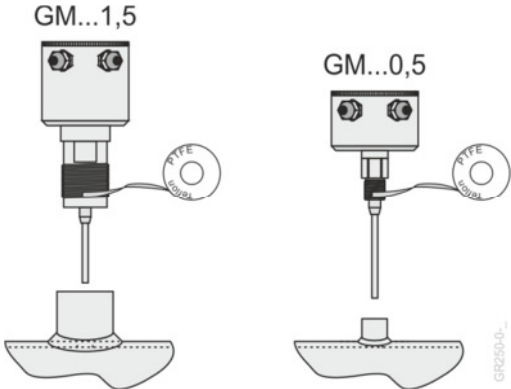

Fig. 11 Apply the sealant

- 4. Tighten the device with a spanner:

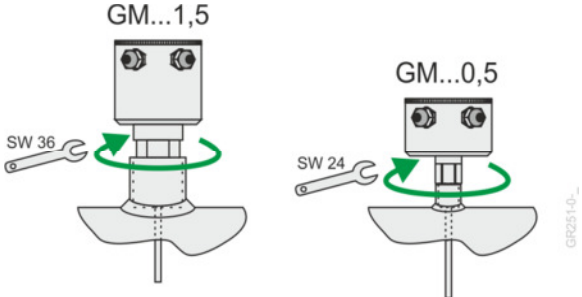

Fig. 12 Affix the device

- 5. Establish grounding:

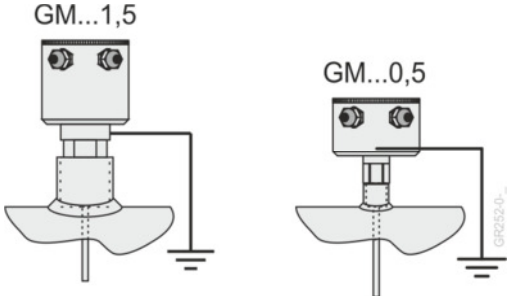

Fig. 13 Establish grounding

5.1.3 Installation of a Flow-Guard K

The flow direction does not affect the measurement.

5 Commissioning

1. Disconnect the pipeline at a flange.
2. Position the device with the gaskets between the flanges and only gently screw in place for the time being:

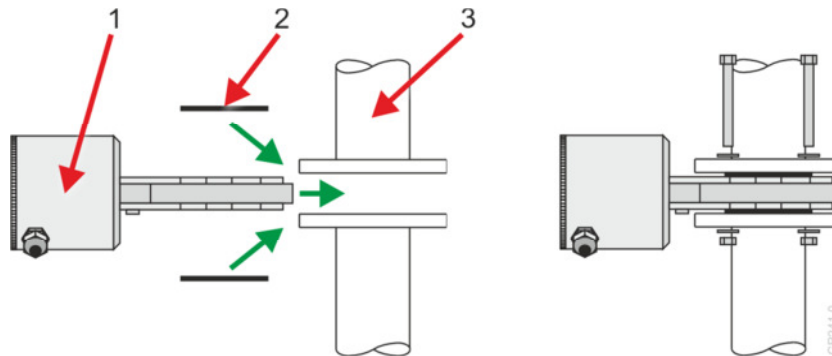

Fig. 14 Installation of the device in the pipeline

- 1 D-guard
- 2 Gasket
- 3 Disconnected pipeline

3. Ensure that the pipe and device are not tilted and are not under mechanical stress. Ensure a centred installation and clean transitions between the process pipe flanges and the process connections of the device in order to avoid turbulence in the sensor area. This increases both the measuring accuracy as well as the service life of the device.
4. Screw together flanges crosswise.
5. Establish grounding:

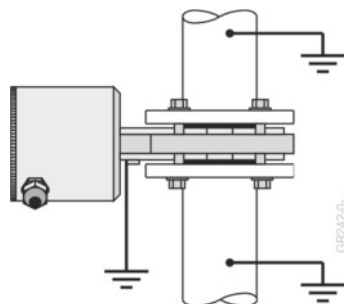

Fig. 15 Establish grounding

5.1.4 Installation of a Flow-Guard P

1. Weld on the welding sockets.
2. Drill into the process pipe through the welding sockets (centric, at least 43 mm (1.4 in)).
3. Apply PTFE sealant to the screw threads:

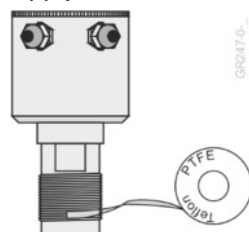

Fig. 16 Apply the sealant

4. Tighten the device with a spanner size SW 36:

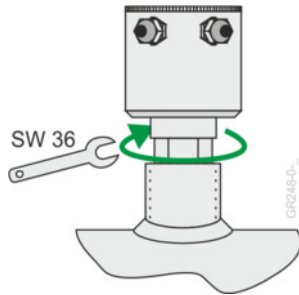

Fig. 17 Affix the device

5. Establish grounding:

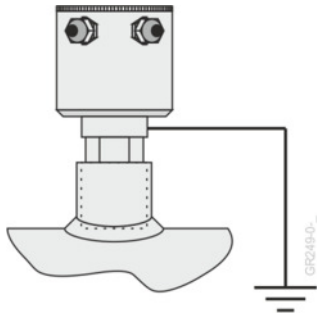

Fig. 18 Establish grounding

5.1.5 Installation of a Flow-Guard S...E

The flow direction does not affect the measurement.

1. Screw the device together with the mounting plate at the site of installation.
2. Disconnect the hose.
3. Connect the hose to the hose connections. The hose ends lock automatically:

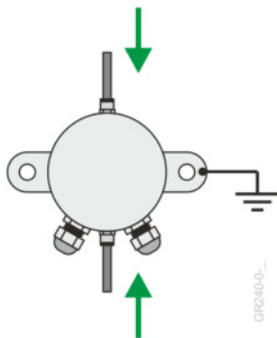

Fig. 19 Insert the hose ends

4. Establish grounding.

5.1.6 Installation of a Flow-Guard S...T

The flow direction does not affect the measurement.

1. Screw the device together with the mounting plate at the site of installation.
2. Loosen the nuts on the hose inlets.

5 Commissioning

3. Push the hose through the device:

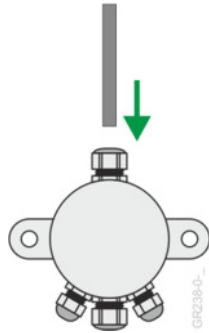

Fig. 20 Guide the hose through the device

4. Tighten the nuts at the hose inlets and establish grounding:

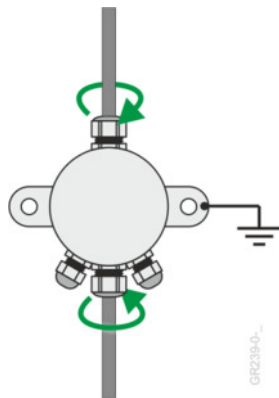

Fig. 21 Affix the hose

5.1.7 Installation of a Flow-Guard V

The flow direction does not affect the measurement.

1. Remove the protective cap from the device.
2. Connect the device to the connecting piece:

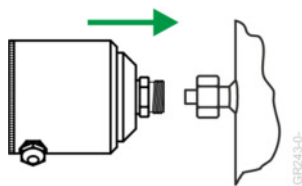

Fig. 22 Connect the device

3. Hand-tighten the nuts of the connecting piece:

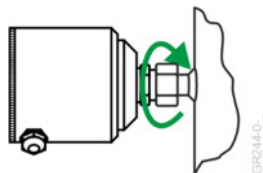

Fig. 23 Gently tighten the nuts

5 Commissioning

- Rotate the device to the desired position:

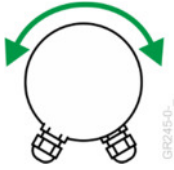

Fig. 24 Rotate the device

- Affix the device with a spanner size SW 27 and tighten the nuts with a spanner size SW 32:

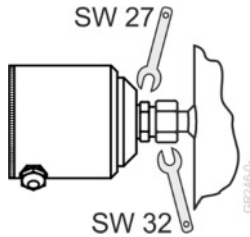

Fig. 25 Affix the device

- Establish grounding. Follow the separate operating instructions of the sensor mechanics for this.

5.1.8 Finishing Tasks

- Ensure that the voltage specified on the label coincides with the power supply.
- Open the housing cover.
- Remove the screw adapter of the cable gland and push this over the cable to be inserted.
- Remove the outer sheath of the cable so far that the rubber gasket in the cable gland can still form a seal on the outer sheath.
- Guide the cable through the cable glands and screw into the terminals with 0.4 ... 0.5 Nm according to the following diagram:

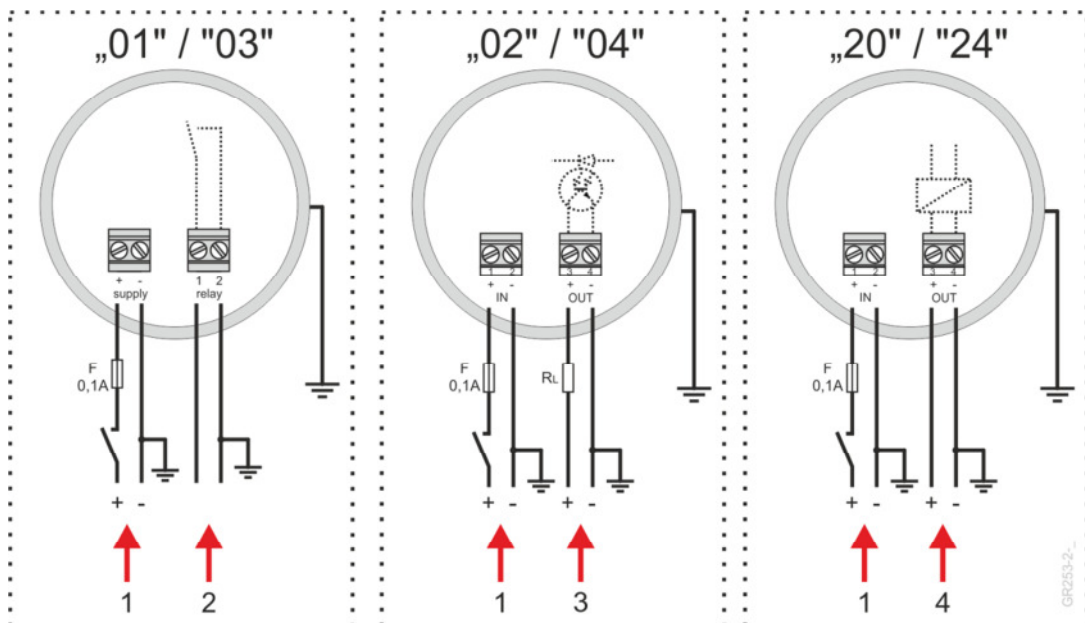

Fig. 26 Connection of output types 01, 02 and 20 to the terminals

- Power supply in accordance with the label and technical specifications
- Relay output (max. load according to the technical specifications)
- Transistor switch output (max. load according to the technical specifications)
- Current output

Note:

The outputs of all output types are galvanically separated from the power supply in the device.

5 Commissioning

6. Ground one core of the power supply to each output (see Fig. 26).
7. Check the cable inlet area for contamination and clean if necessary.
8. Fasten the screw adapter again and tighten so that the gaskets rest tight against the cable.
9. Provide unused cable inlets with the Ex-approved dummy plugs for the application temperature range (included in the package content) and screw in place.
10. Screw the cable inlets tight enough to ensure the IP protection.
11. Guide the cable so that moisture is not transferred to the device:

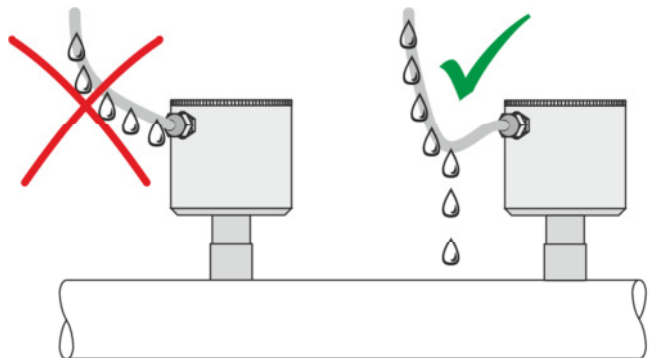

Fig. 27 Poor and good cable routing

12. Ensure that the gasket ring is fully seated and screw the cover tightly down again so that the IP protection is ensured.
13. Ensure that the potential equalisation has been properly established.

5.2 Initial Start-up

1. Ensure that all cable connections are established correctly.
2. Apply the operating voltage.

5.3 Adjustment to the Process

Before productive application of the device, the basic settings must be configured so that the device reacts to changes in the particle flow as desired.

Chapter 5.3.1 covers everything about the operating and display elements in the device and their configurations/interpretations.

Chapter 5.3.2 provides information on how you should configure the device for certain applications.

Please note:

When closing the cover, ensure that the gasket ring is fully seated.

5.3.1 Operational and Display Elements and their Uses

Since operational and display elements are only required during device configuration, they are located on a circuit board inside the head housing. You therefore need to remove the cover for configuration.

5.3.1.1 Operational and display elements of connection types 01, 02, 03 and 04

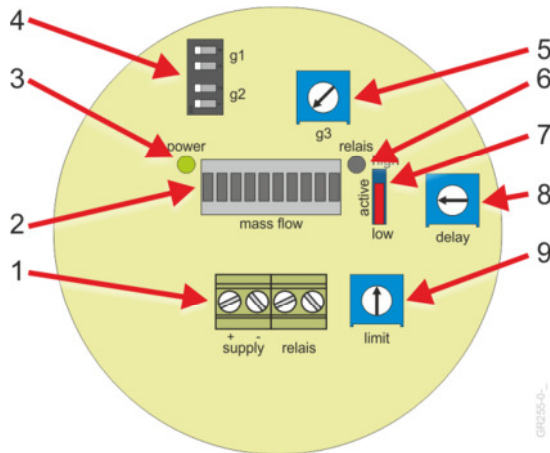

Fig. 28 Components on the circuit board (output types 01, 02, 03 and 04)

- 1 Connection terminals
- 2 Mass flow display
- 3 Operational display
- 4 Amplification setting levels 1 and 2
- 5 Amplification setting level 3
- 6 Alarm display
- 7 Selector switch for switching behaviour
- 8 Delay setting
- 9 Configuring the triggering threshold

Connection terminals

You will find information on the use of the connection terminals in chapter 5.1.8.

Mass flow display

This LED bar on the device shows how much mass flow is currently being detected. If no mass flow is detected, then no LED lights up. In the case of increasing mass flow, the LED on the far left lights up first up to the maximum on the far right. The amplification setting can be used to determine how strongly the device is responding to a mass flow.

Operational display

This LED lights up when the device is supplied with power.

Amplification setting levels 1 and 2

The device has three amplifier levels. The multiplication of the amplifications of the three levels provides the overall amplification of the device. The first two levels are controlled by this DIP switch:



Switch setting					
Amplification	Low	↔	↔	↔	High

Tab. 14 DIP switch settings

5 Commissioning

Amplification setting level 3

The amplification of level 3 is set variably:

Potentiometer setting (examples)	Amplification level 3
	Low
	High



Tab. 15 Potentiometer settings level 3

Alarm display

This LED lights up if an alarm is present and the output is active.

Selector switch for switching behaviour

This switch specifies in which cases the device enters an alarm state (switch output closed):

Switch setting	Alarm if:
	Material flow is below the triggering threshold.
	Material flow is above the triggering threshold.

Tab. 16 Function of the selector switch for switching behaviour

If the device is not supplied with power, then the switch output is open.



Consider the following when selecting the switching behaviour: How should the connected evaluation system behave in the event of device power failure? In such a case, the device does no longer provide a valid status. Should the evaluation system then assume a material flow above or below the triggering threshold? If the device should assume a material flow below the triggering threshold, then select the switch setting "high". Otherwise select "low".

Delay setting

The delay smooths out the measured values. A higher value is smoothed out more strongly, but also delays the response to a changing flow throughput.

A stronger delay is therefore always useful when alarm outliers should to be prevented in the case of short mass throughput peaks and a fast response is not required.

The delay is variably adjusted:







Potentiometer setting (examples)	Delay time	Response to a mass throughput change	Alarm behaviour
	1 s (minimum)	Fast	Turbulent
	10 s (maximum)	Slow	Calm

Tab. 17 Delay: Potentiometer settings

5 Commissioning

Configuring the triggering threshold

This potentiometer determines which LED (when lighting up) puts the device in an alarm state:

Potentiometer setting (examples)	Triggering by LED
	
	
	

Tab. 18 Triggering threshold: Potentiometer settings

5.3.1.2 Operational and display elements of connection types 20 and 24

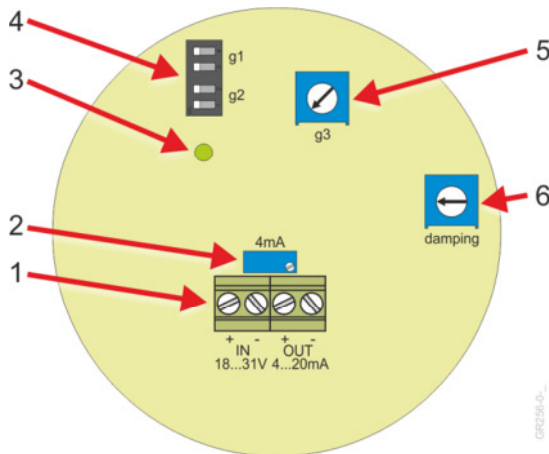

Fig. 29 Components on the circuit board (output types 20 and 24)

- 1 Connection terminals
- 2 Adjustment potentiometer of the current output
- 3 Operational display
- 4 Amplification setting levels 1 and 2
- 5 Amplification setting level 3
- 6 Delay setting

Connection terminals

You will find information on the use of the connection terminals in chapter 5.1.8.

Adjustment potentiometer of the current output

This potentiometer serves to adjust the output current when there is no material flow. This potentiometer is adjusted in the factory. Please do not change the configuration.





Operational display

This LED lights up when the device is supplied with power.

5 Commissioning

Amplification setting levels 1 and 2



The device has three amplifier levels. The multiplication of the amplifications of the three levels provides the overall amplification of the device. The first two levels are controlled by this DIP switch:

Switch setting					
Amplification	Low	↔	↔	↔	High

Tab. 19 DIP switch settings

Amplification setting level 3

The amplification of level 3 is set variably:

Potentiometer setting (examples)	Amplification level 3
	Low
	High



Tab. 20 Potentiometer settings level 3

Delay setting

The delay smooths out the measured values. A higher value is smoothed out more strongly, but also delays the response to a changing flow throughput.

A stronger delay is then useful if the current output of short mass throughput peaks should be prevented and a fast reaction is not required.

The delay is variably adjusted:

Potentiometer setting (examples)	Delay time	Response to a mass throughput change	Current output
	1 s (minimum)	Fast	Turbulent
	120 s (maximum)	Slow	Calm

Tab. 21 Delay: Potentiometer settings

5.3.2 Configuring Instructions for Typical Areas of Application

5.3.2.1.1 Throughput Monitoring with Switch Output (Output Types 01, 02, 03 and 04)

The operational and display elements of this device version are described in chapter 5.3.1.1.

Choose the switching behaviour:

Note the considerations for choosing the switching behaviour in chapter 5.3.1.1.

5 Commissioning

Choose the correct amplification:

1. Set the delay for the adjustment to 20%.
2. Set the level 3 amplification to maximum.
3. Set the amplification of levels 1 and 2 to 1.
4. Allow the material to flow at the standard throughput.
5. Increase the amplification of levels 1 and 2 gradually until an LED in the right area lights up.
6. Lower the amplification of level 3 until one of the middle LEDs lights up.

Choose the delay:

Set the delay so that the LED no longer follows every small change in flow.

Set the triggering threshold:

Set a sufficient interval between the normal and alarm states.

5.3.2.1.2 Throughput Monitoring with Current Output (Output Types 20 and 24)

The operational and display elements of this device version are described in chapter 5.3.1.2.

Choose the correct amplification:

1. Set the delay for the adjustment to 20%.
2. Connect the ampere meter to the current output.
3. Set the level 3 amplification to maximum.
4. Set the amplification of levels 1 and 2 to 1.
5. Allow the material to flow at the standard throughput.
6. Gradually increase the amplification of levels 1 and 2 until the ampere meter shows more than 12 mA.
7. Lower the amplification of level 3 until the ampere meter shows about 12 mA.

Choose the delay:

Set the delay so that the current output no longer follows every small change in flow.

5.3.2.1.3 Filter Monitoring with Relay Output (Output Types 01, 02, 03 and 04)

The operational and display elements of this device version are described in chapter 5.3.1.1.

Choose the switching behaviour:

We recommend setting the switching behaviour to "low active". Both power failure and too much particulate matter in the line will therefore lead to an alarm state.

Choose the correct amplification:

1. Set the delay for the adjustment to 20%.
2. Set the amplification of levels 1 and 2 to maximum.
3. Allow the material to flow at the standard throughput.
4. Set the amplification of level 3 to maximum and then lower it until the first or second LED from the left lights up.
5. If this is not possible: Reduce the amplification of levels 1 and 2 and repeat the previous step.

Choose the delay:

We recommend setting the delay to 50%.

Set the triggering threshold:

Set a sufficient interval between the normal and alarm states.

5.3.2.1.4 Filter Monitoring with Current Output (Output Types 20 and 24)

The operational and display elements of this device version are described in chapter 5.3.1.2.

Choose the correct amplification:

1. Set the delay for the adjustment to 20%.
2. Connect the ampere meter to the current output.
3. Set the amplification of levels 1 and 2 to maximum.
4. Allow the material to flow at the standard throughput.
5. Set the amplification of level 3 to maximum and then lower it until the ampere meter shows a maximum of 8 mA.
6. If this is not possible: Reduce the amplification of levels 1 and 2 and repeat the previous step.

Choose the delay:

We recommend setting the delay to 50%.

6 Operation

During normal running, it is not necessary to operate the device. All control elements are located inside the closed device.

The device can and should be used in continuous operation.

7 Servicing

The functional behaviour of the device is stable even over long periods of time. Regular adjustments and the like are therefore not required. The device is consequently largely maintenance-free. The following activities should, however, be performed:

Activity	Frequency
<p>Depending on the process, the sensor element is subject to notable wear. This part must therefore be checked regularly for damage.</p> <p>The loss of material may not account for more than 1 mm. If this loss is exceeded, the part must be replaced. If not replaced, pressure safety is no longer guaranteed.</p>	<p>Annually; more frequently in the case of abrasive materials and/or high conveying velocities</p>
<p>Remove particulate matter from the outside of the head housing.</p>	<p>Annually; more frequently in very dusty environments.</p>

Tab. 22 Maintenance work

8 Troubleshooting and Repair

8 Troubleshooting and Repair

As soon as a fault in the device is noted, check the following:

- Has regular maintenance work been carried out?
- Is the installation still correct (secure installation, correct and undamaged wiring)?
- Is the grounding still correct?
- Are the settings of the device unchanged?

Customers cannot service internal parts. Repair therefore often requires the device to be returned to the factory. If this should be necessary, please contact DYNA Instruments for further details on the repair procedure.

9 Decommissioning

9.1 Dismantling



WARNING

Danger of product leakage (or pressurisation).

Depressurise the conveyor pipeline before dismantling.

Leaking product may result in injury to any unprotected body parts.

1. Disconnect the power supply.
2. Loosen and remove the cable (see installation in chapter 5.1.8).
3. If the cables are still to be used for another device, electrically isolate the ends of the cables and store them safely until they are reused.
4. Loosen the mechanical connection.
5. Remove the device.
6. Close the pipeline.

9.2 Disposal

Dispose of packaging according to local regulations.

Device disposal:

1. Clean the sensor element if there is any residue from hazardous substances on the sensor element.
2. Dispose of device according to local regulations. If the device is sent to DYNA Instruments free of charge, proper disposal is ensured.

